

BenQ Board

Quick Start Guide

Target Model:RP05

<Index>

- [Components](#)
- [Initial Set up](#)
- [Recommend Setting](#)

How to use BenQ Board

[①Mirroring Device Screen with Cables](#)

[②Wireless Mirroring](#)

[③Whiteboard App](#)

[④Open Data Files](#)

[⑤How to use Google Play](#)

[⑥Switching Audio input](#)

- [Troubleshooting](#)

- Components

Components (Front panel)

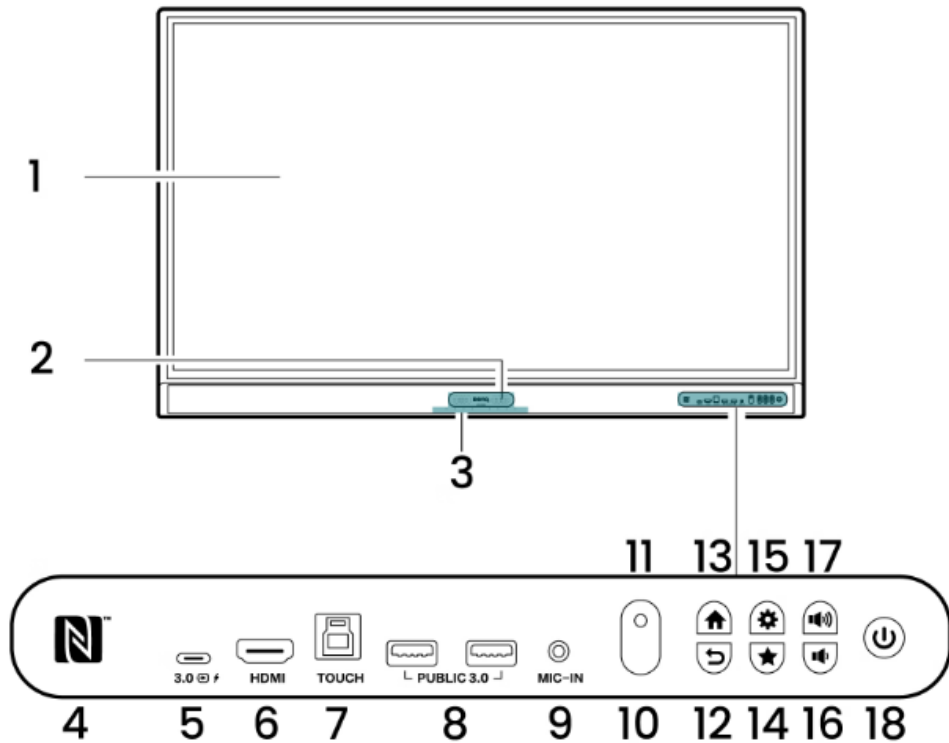

- | | |
|--------------------------|-------------------------|
| 1.Touchscreen | 10.IR sensor |
| 2.Air ionizer | 11.Ambient light sensor |
| 3.8-microphone array | 12.Back button |
| 4.NFC sensor | 13.Home button |
| 5.USB Type-C port | 14.Customized button |
| 6.HDMI in port | 15.Setting down button |
| 7.Touch USB Type-B port | 16. Volume down button |
| 8.USB Type-A port | 17. Volume up button |
| 9.3.5 mm microphone jack | 18.Power button |

Components (Right panel)

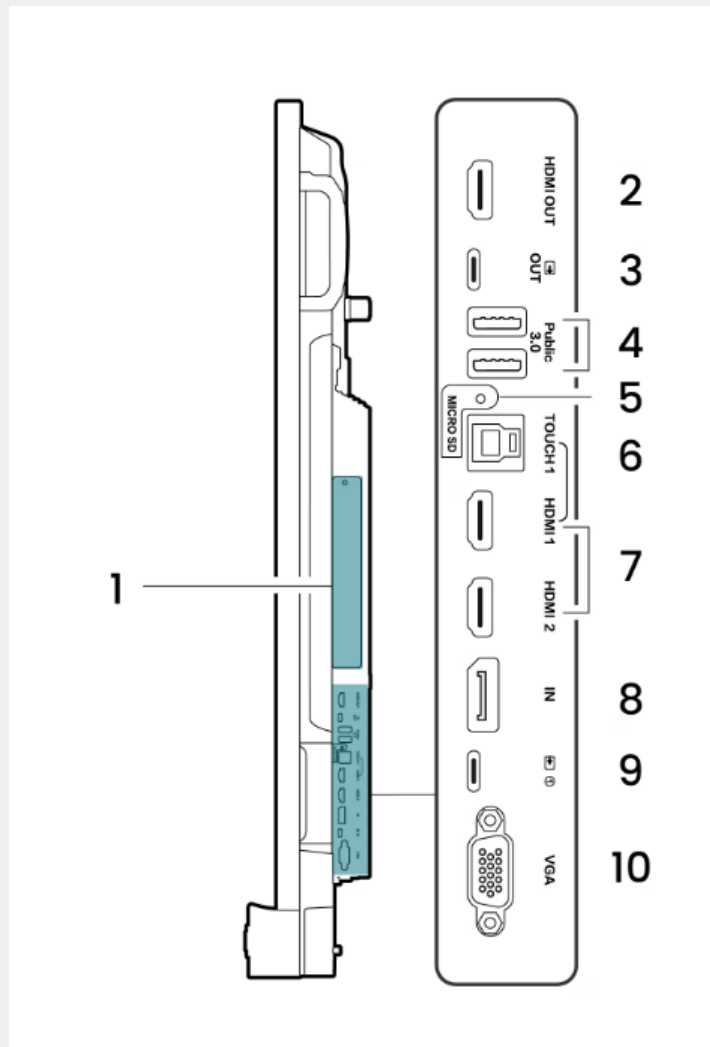

- 1. OPS slot with cover
- 2. HDMI out port
- 3. USB Type-C out port
- 4. USB Type-A ports
- 5. microSD card slot with cover

- 6. Touch USB Type-B port
- 7. HDMI in ports
- 8. DisplayPort port
- 9. USB Type-C port
- 10. VGA port

Components (Bottom panel)

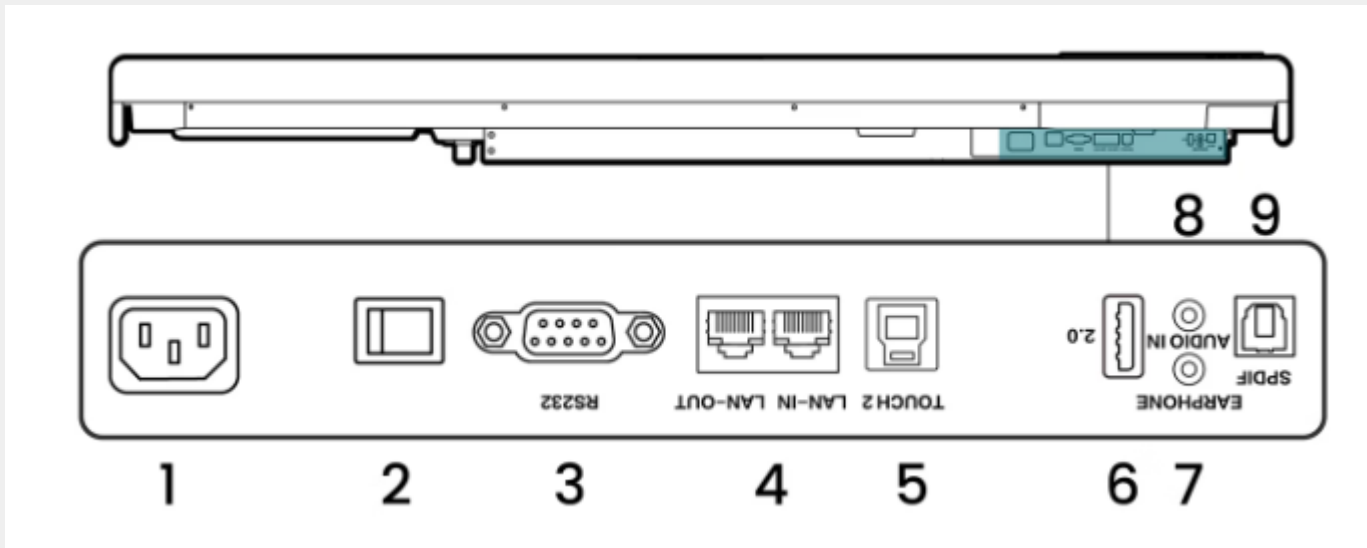

1. Power input

2. Power switch

3. RS232 port

4. LAN port

5. Touch USB Type-B port

6. USB Type-A port

7. Audio out

8. Audio in

9. S/PDIF port

Components (Rear panel)

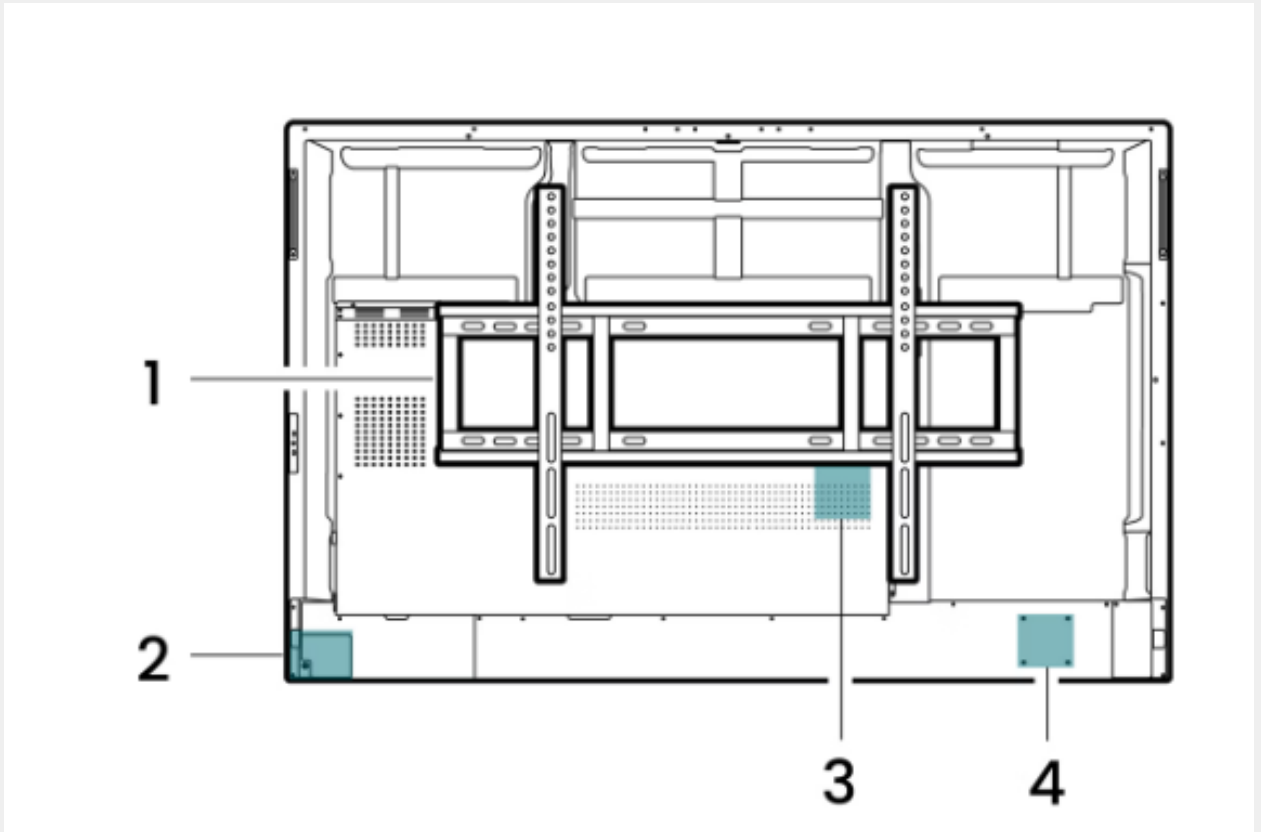

1. Wall mount(pre-installed)
2. USB Type-A port for remote control and Wi-Fi
3. 20 W subwoofer
4. Mini PC screw holes

Remote control

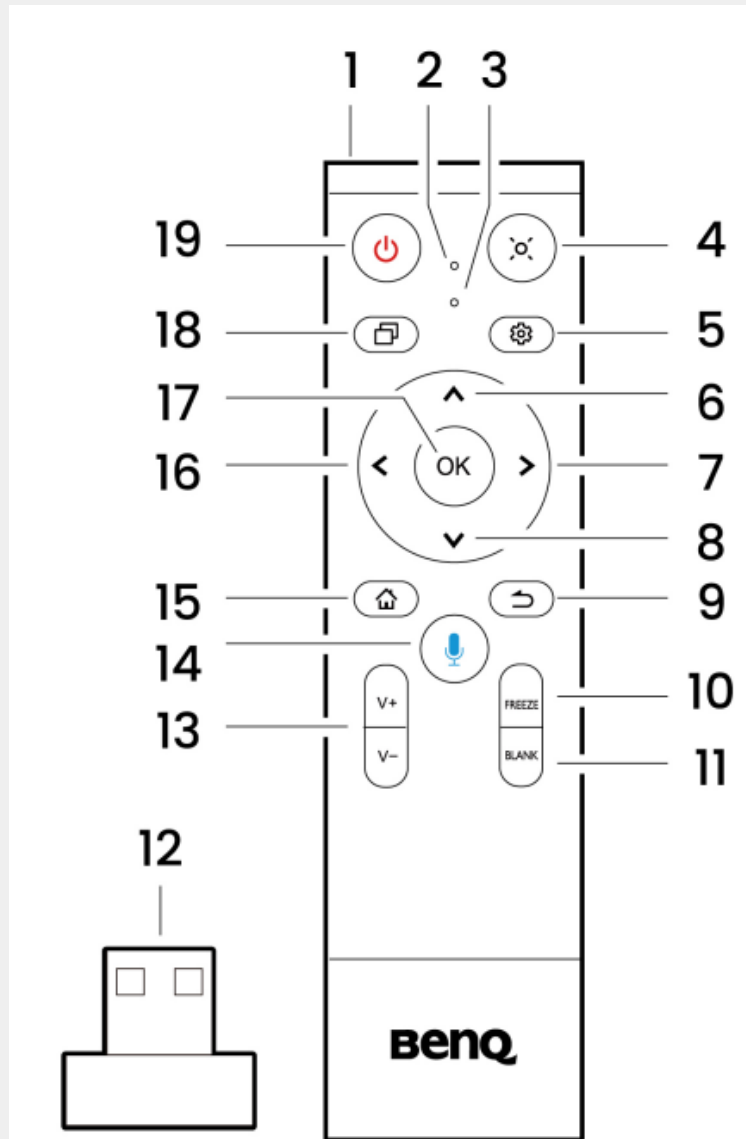

1.Signal transmitter

2.Status LED

3.Microphone

4. Laser pointer/Spotlight button

5.Setting button

6.Up button

7.Right button

8.Under button

9.Back button

10.Freeze screen button

11.Blank screen button

12.Remote control receiver

13.Volume buttons

14.Google Assistant button

15.Home button

16. Left button

17.OK button

18.Recent apps and sources button

19.Power button

- Initial Set up

Initial setup

1. Use the included power cable to connect the BenQ Board to an electrical outlet.

2. Turn on the power switch.

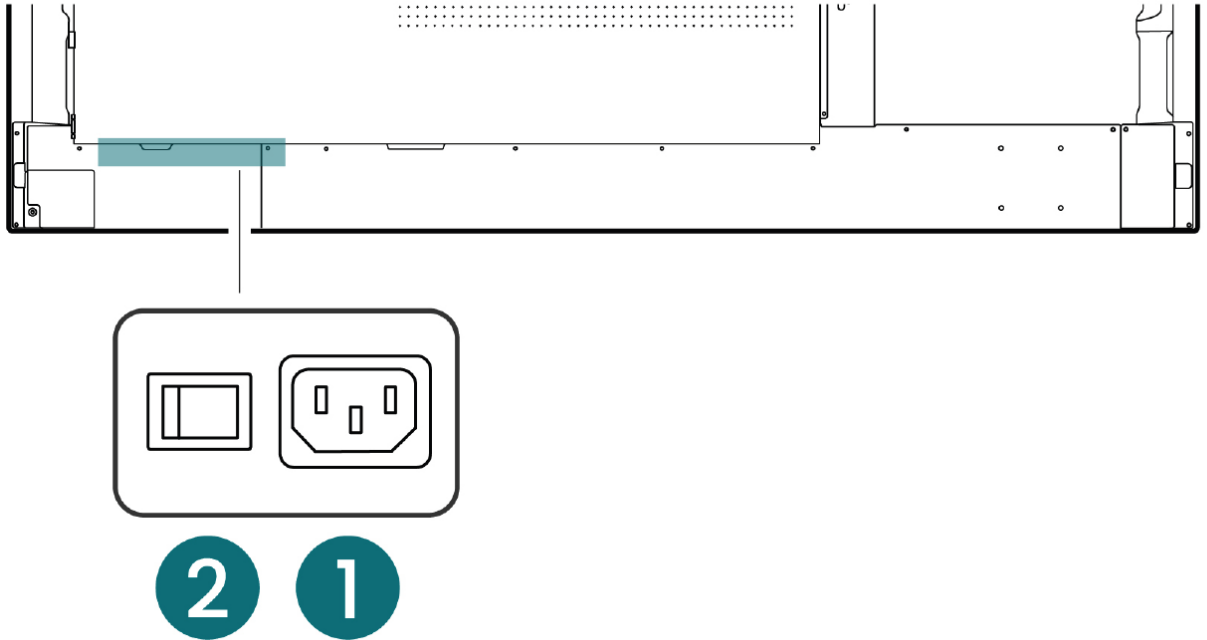

3. Press the power button on the front panel or the remote control to turn on the BenQ Board.

*When using the remote control, please make sure the USB receiver is plugged into the BenQ Board.

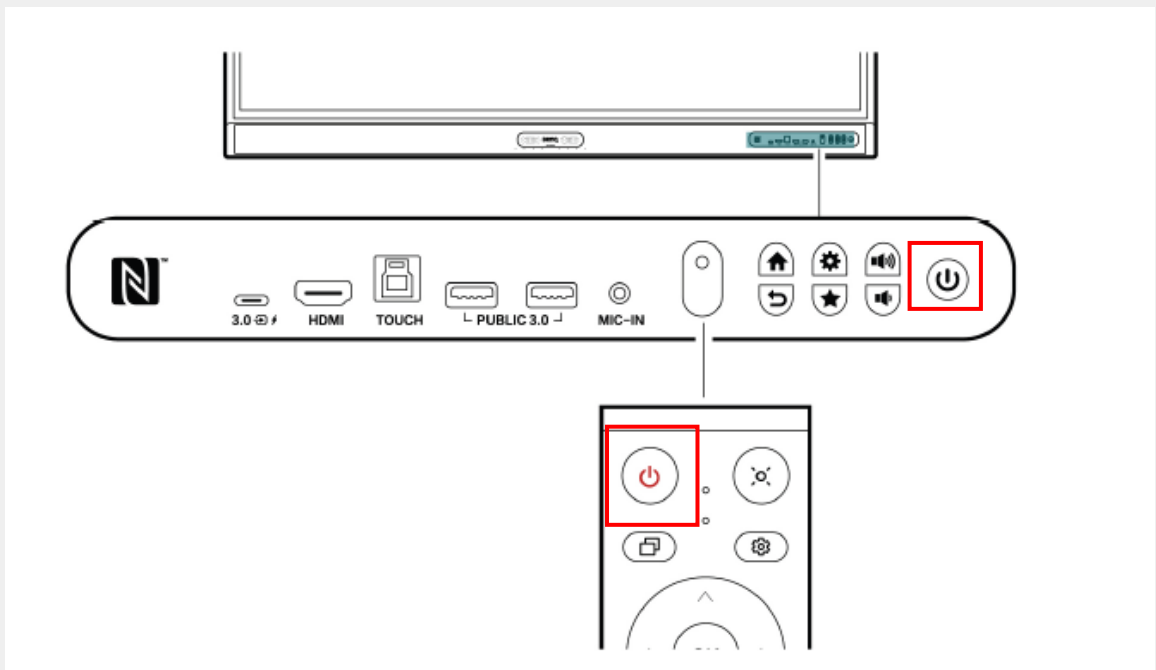

Initial setup

1. When you first turn ON your BenQ Board, an initial set up wizard will launch.

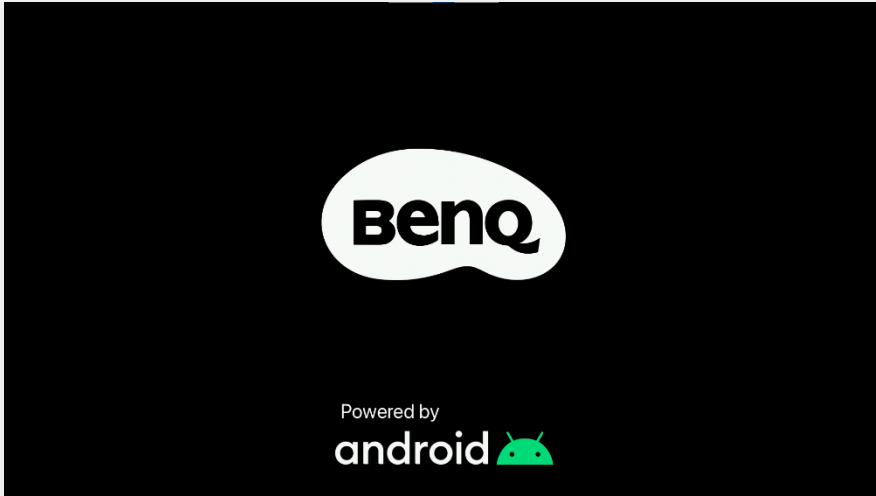

2. Choose your preferred Language.

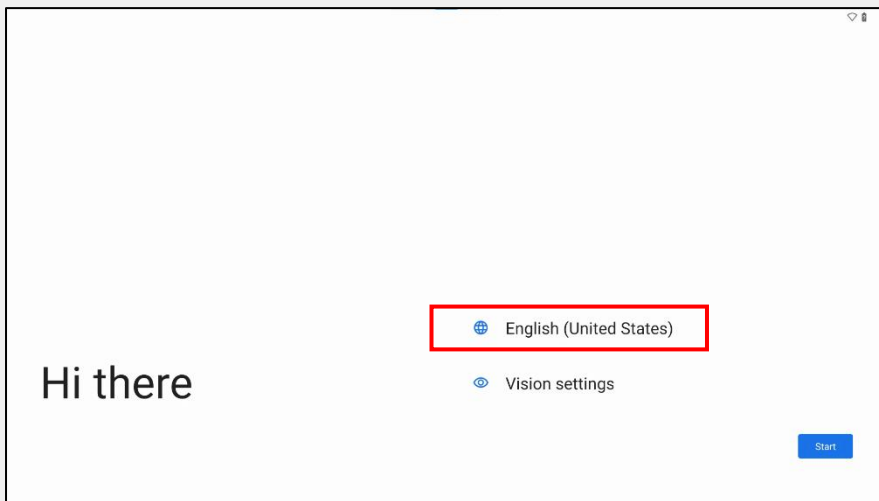

3. Setup and connect to a network.

*You can configure your internet connection settings later, so it's fine to set them up offline.



Initial setup

4. Wait until the tablet setting is complete.



5. Copy your apps and data from another device to the BenQ Board or tap Don't copy too continue without copying anything.



6. Sign in with a Google account, or tap skip to continue without signing in.



Initial setup

7. Accept or decline the Google service.



8. Set a PIN to setup a Screen lock, or tap skip to continue without setting one.

*If you have set a PIN and no longer recognize it, please contact the Repair Consultation Service. We will perform the forced cancellation for a fee. Please note that we cannot guarantee the loss of data, etc., since the operation involves initialization. Please understand this beforehand.

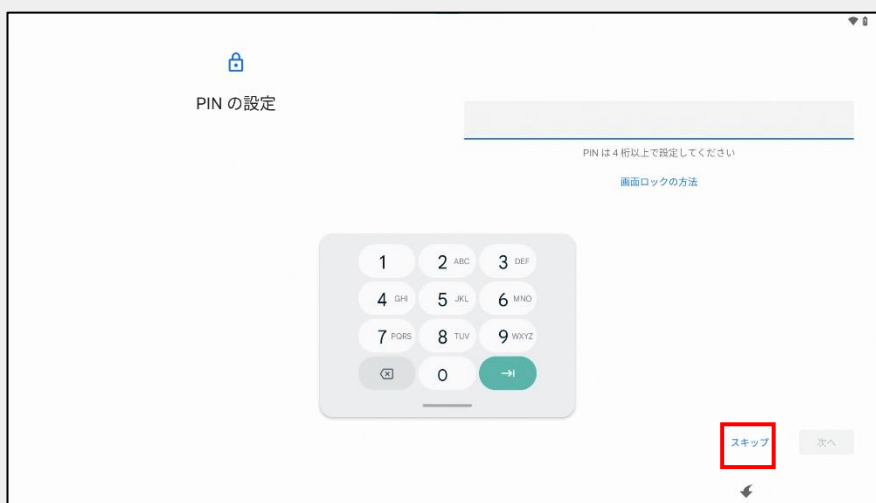

9. In navigation mode, select Next.

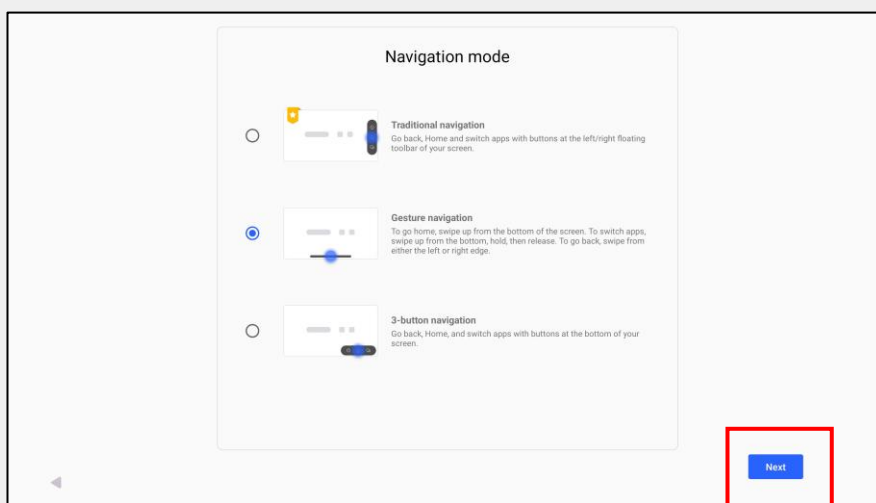

Initial setup

10. Accept the End-User License Agreement.

End-User License Agreement(EULA)

obligations under these license terms.

Miscellaneous.

(a) These license terms constitutes the entire agreement between BenQ and you concerning the subject matter hereof, and it may only be modified by a written amendment signed by an authorized executive of BenQ. (b) Except to the extent otherwise provided under applicable law, these license terms will be governed by the law of the Republic of China, excluding its conflict of law provisions and excluding the United Nations Convention on the International Sale of Goods. For any disputes arising out of, or relating to, this contract, the Taiwan Shilin District Court shall be the exclusive court of jurisdiction for the first instance. (c) If any part of these license terms is held invalid or unenforceable, and the remaining portions will remain in full force and effect. (d) A waiver by either party of any term or condition of these license terms or any breach thereof, in any one instance, will not waive such term or condition or any subsequent breach thereof. (e) BenQ may assign its rights under these license terms without condition. (f) These license terms will be binding upon and will inure to the benefit of the parties, their successors and permitted assigns.

Last update: 2024/10/22

I accept the terms of the license agreement

Next

11. Agree to Privacy Policy.

Privacy Policy

use our services.

Data Retention

We will not keep your personal data for longer than is reasonably necessary for the purpose it was collected. This means that we process and retain information about you at least the duration for which the information is used to provide you with a service. Despite your request for deletion, BenQ reserves the right to keep the residual personal information, or a relevant part of it, in BenQ's records and archives for some time, in compliance with applicable law, but BenQ will not use that information for commercial purposes.

Contact us

If you have any specific questions, please contact us at:

BenQ Corporation 15 Jihu Road Neihu, Taipei 114 Taiwan Phone: +886-2-2727-8899 Fax: +886-2-2656-2438	BenQ Europe B.V. Meerenskerweg 1-17, 5652 AR Eindhoven, The Netherlands Phone: +31(0)88 888-9200 Fax: +31(0)88 888-9299
--	---

Agree Disagree

Next

12. Activate BenQ Service.

*If you proceed without enabling BenQ services, some BenQ apps may not be available.

BenQ

Get more with BenQ services!

BenQ services offer the following benefits:

- 1. Remote device management**
Conveniently manage all your BenQ devices anywhere, at any time.
- 2. Account management**
Synchronize with your directory service and allow users to personalize their settings.
- 3. Enhanced productivity**
Through the BenQ service portal, you can access the full range of BenQ tools you need to maintain all your BenQ devices.

Enable BenQ services

The device will restart to complete the configuration.

Next

Initial setup

13. BenQ Board will reboot.

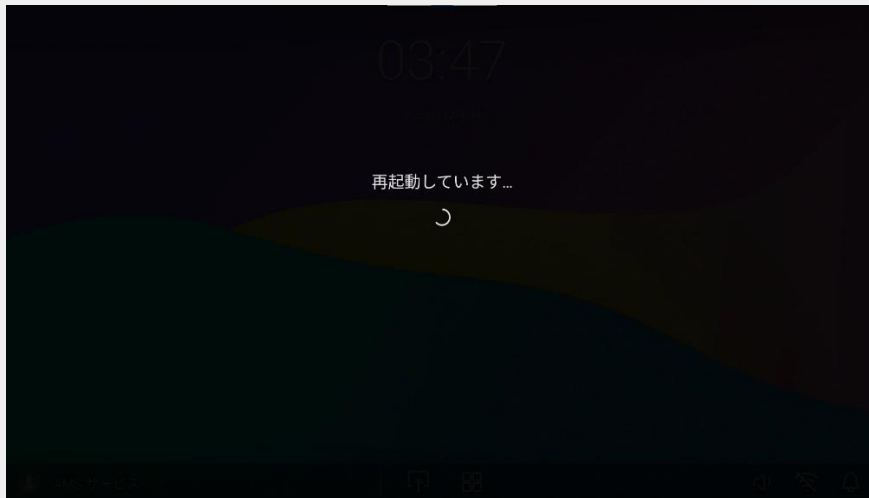

14. After rebooting, select "Activate later" in the Activate Admin Service" pop-up.

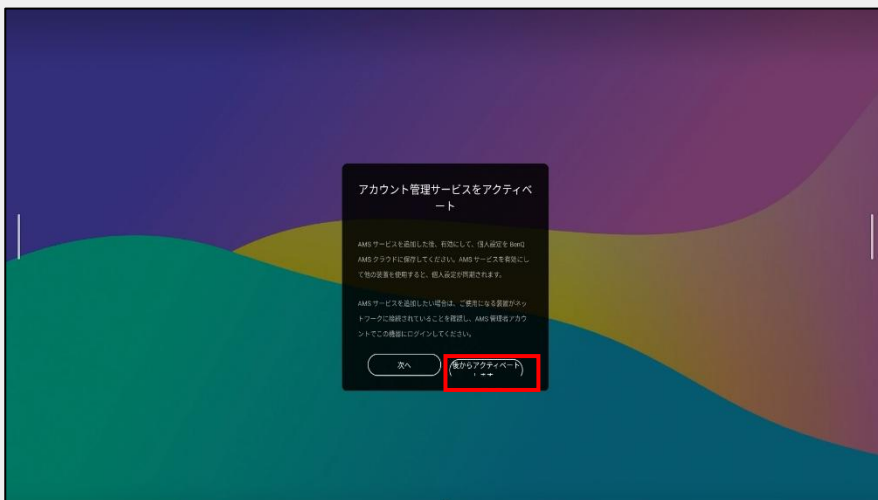

15. BenQ Board Home screen will be displayed. Then, the initial set up is finished.



- Recommend Setting

Power On BenQ Board

There are two ways to power on the BenQ Board.

- Press the power button on the BenQ Board.
- Press the power button on the remote control.

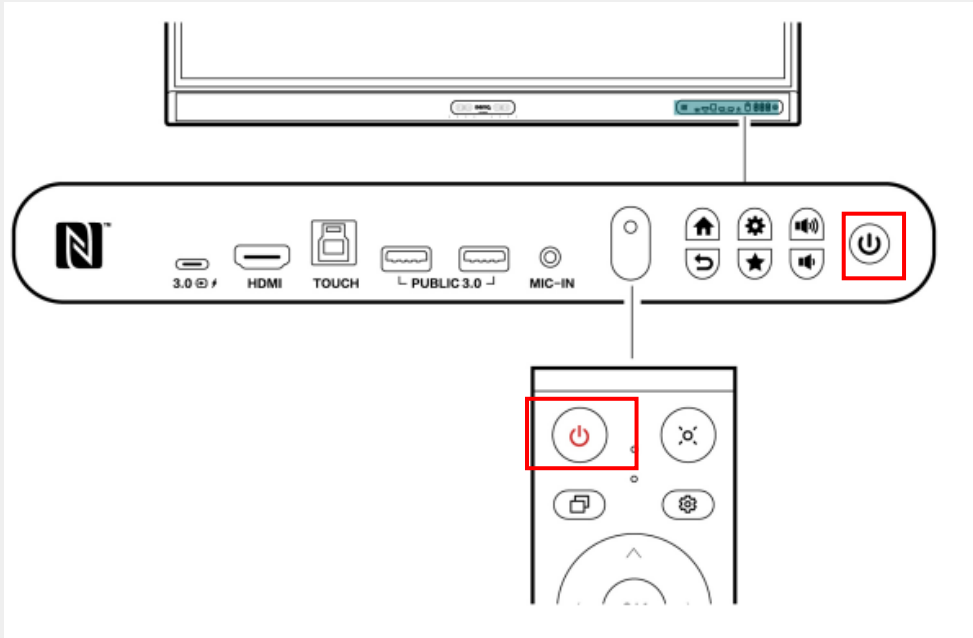

The BenQ Board home screen will be displayed.



- **Sleep Mode:** Press the power button once
- **Shut down:** Press and hold the power button to display the shutdown sequence pop-up; select OK, or the device will shut down automatically after 10 seconds.

Recommend Setting

In order to use the latest features of BenQ Board, please update the firmware and install the BenQ applications.

1. Select the Setting button icon on the remote control or front panel.

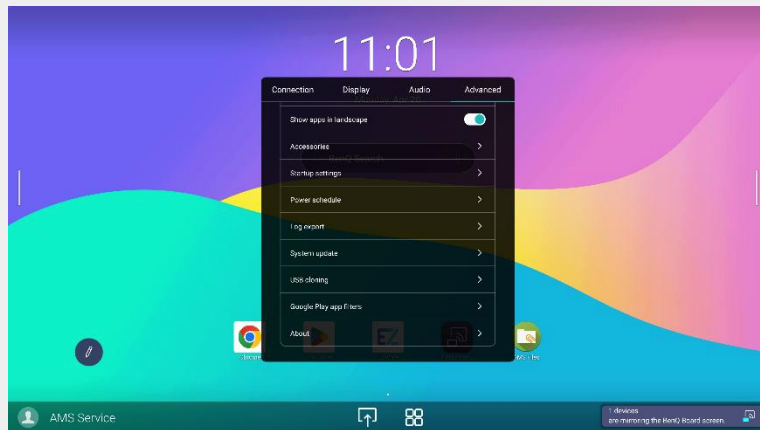

2. From Advanced , select "System Update".

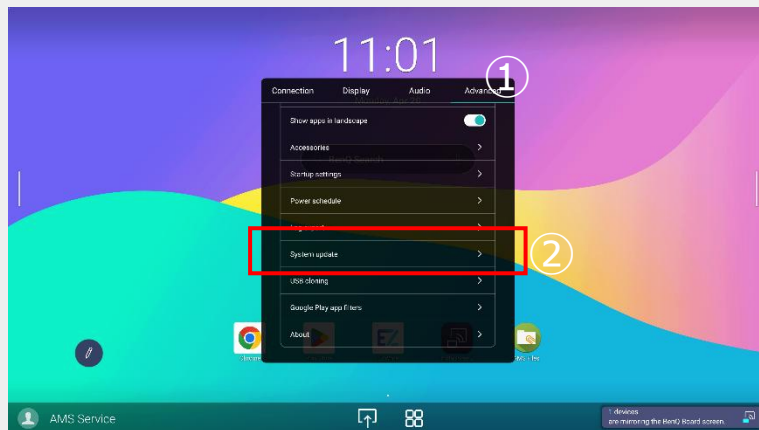

3. Select "Start update" and confirm the firmware update of the BenQ Board main system.

*Internet connection required.

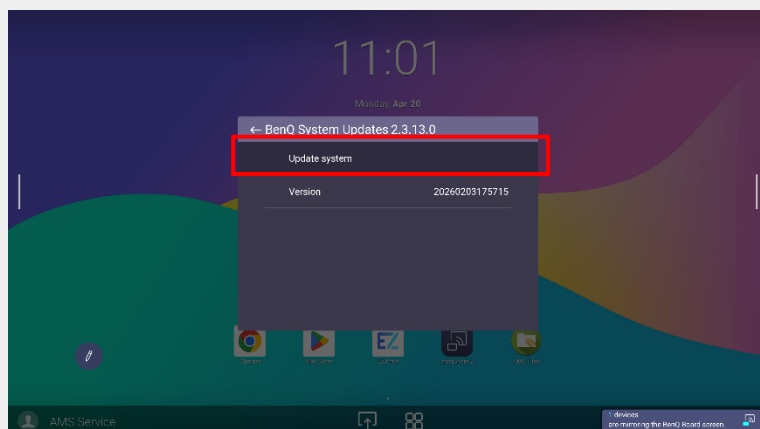

Recommend Setting

4. From the home screen, select BenQ Store from the Apps menu.

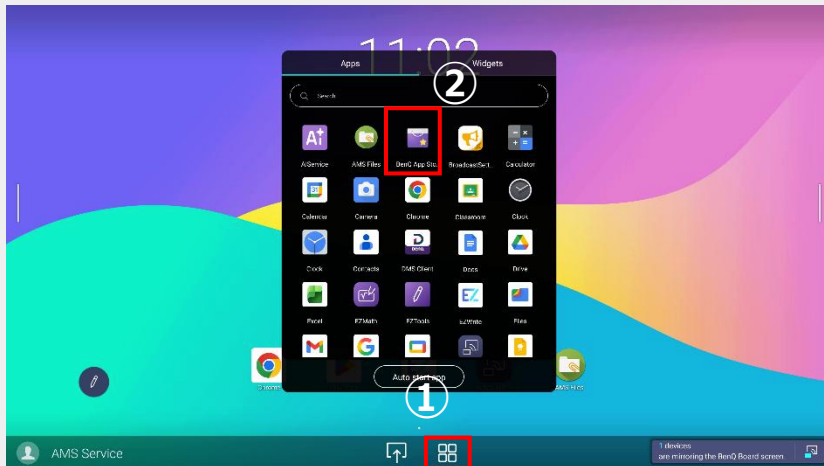

5. Select "BenQ Apps" Tab.

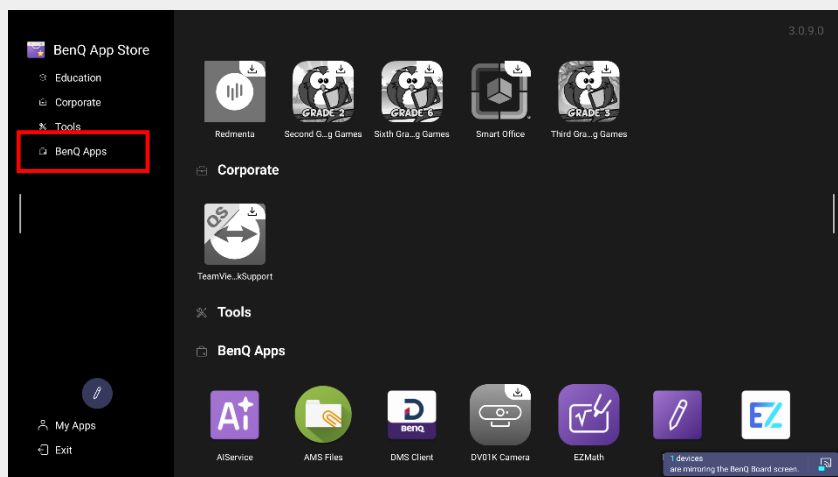

6. Select the "BenQ app with the update icon" and update it.

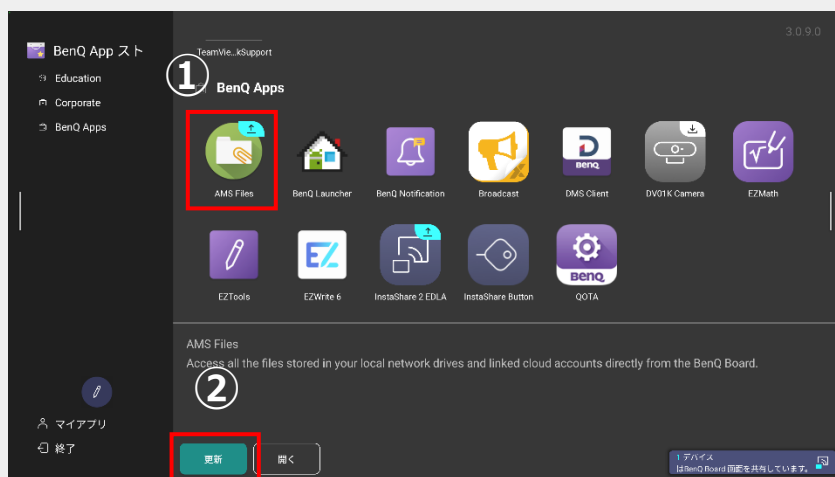

Recommend Setting

In order to use the BenQ Board functions comfortably, Recommend that You allow applications to be stacked on top of each other and add an other language keyboard.

1. Press the Settings button on the remote control or front panel, select the gear icon in the lower-right corner, and launch the Settings app.



2. Settings > From the application, “select the special application access”.

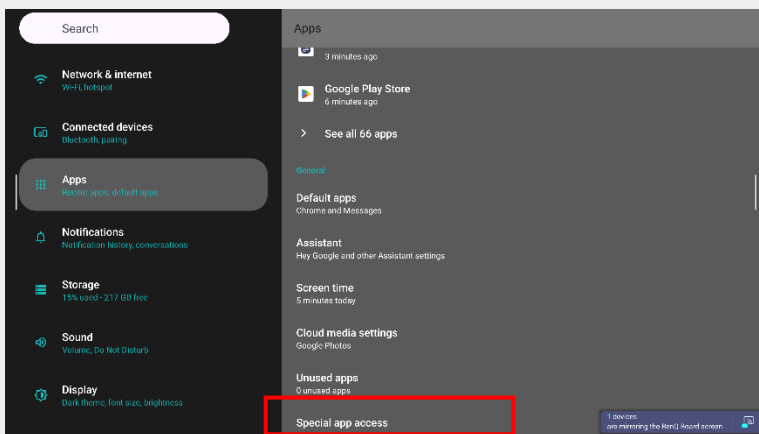

3. From the special app access, select “Display over other apps”.

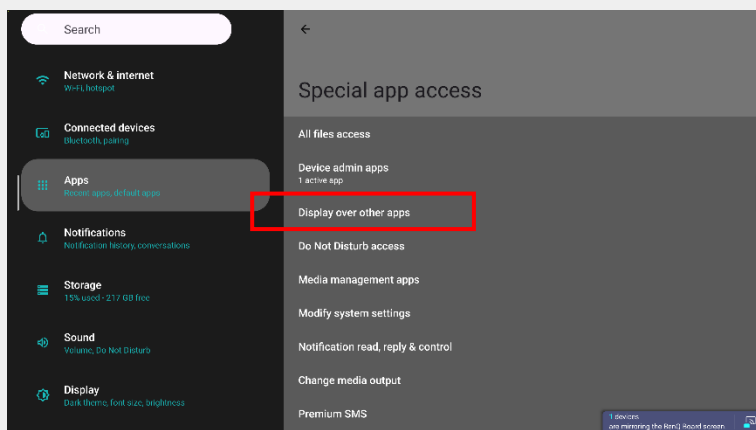

Recommend Setting

4.Change from “Not allowed” to “Allowed”.

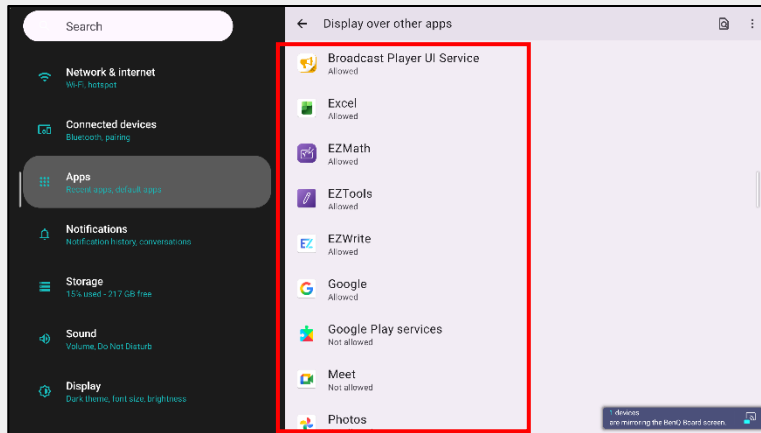

5.Settings> System>Keyboard>Select On-screen Keyboard.

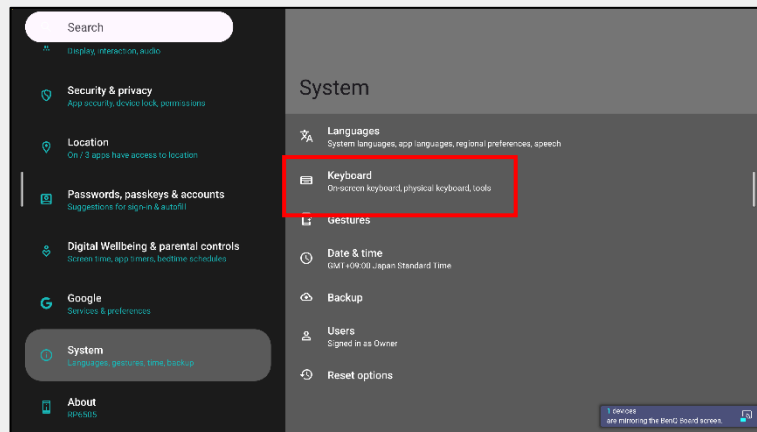

6.Select “Gboard from the on-screen keyboard”.

*Recommend disabling any keyboard settings other than Gboard.

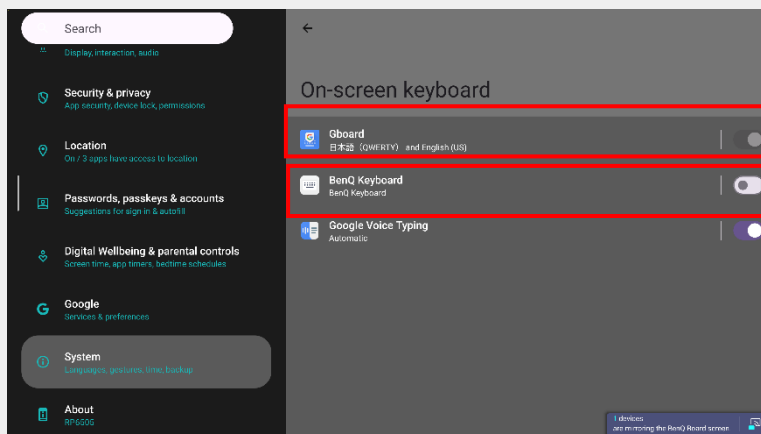

Recommend Setting

7.Under “Language,” select “Japanese,” choose the QWERTY keyboard, and then select “Done.”

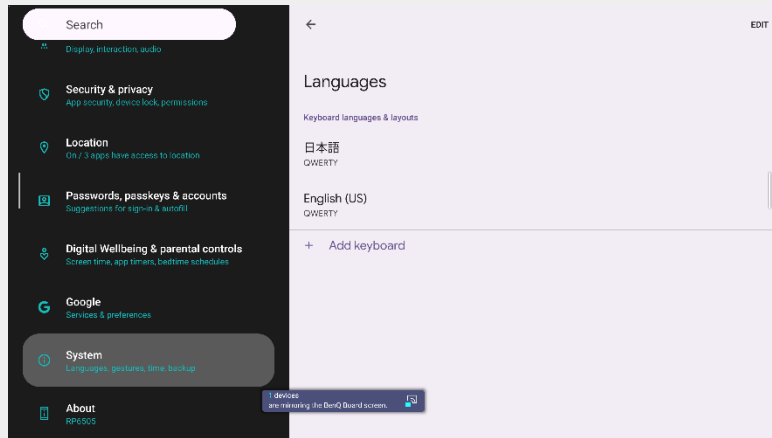

8.From the on-screen keyboard, select Gboard again, then select “Add keyboard” under “Languages.”

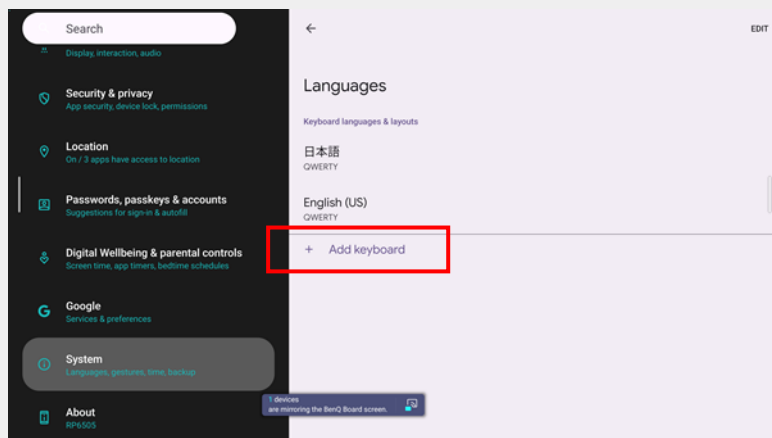

9.From the language list, select English > English (US), choose the QWERTY keyboard, and then select “Done.”

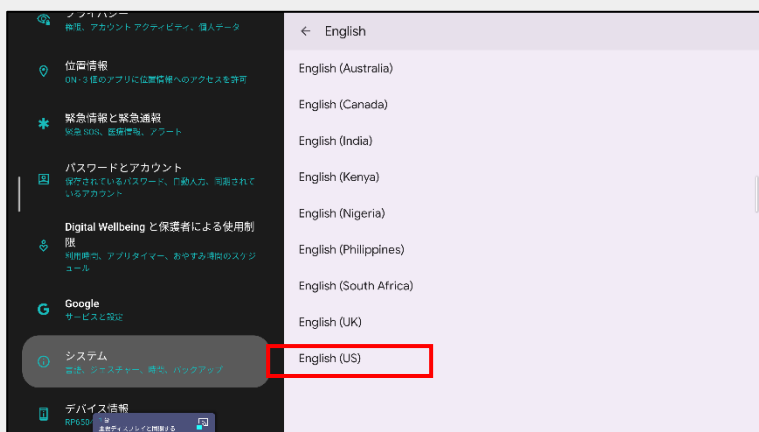

Recommend Setting

To ensure the best experience when using BenQ Board, we recommend adjusting your display settings.

1. Select the Settings button on the remote control or front panel.



2. In the "display settings", turn off "power-saving mode" and set "picture mode" to Standard.

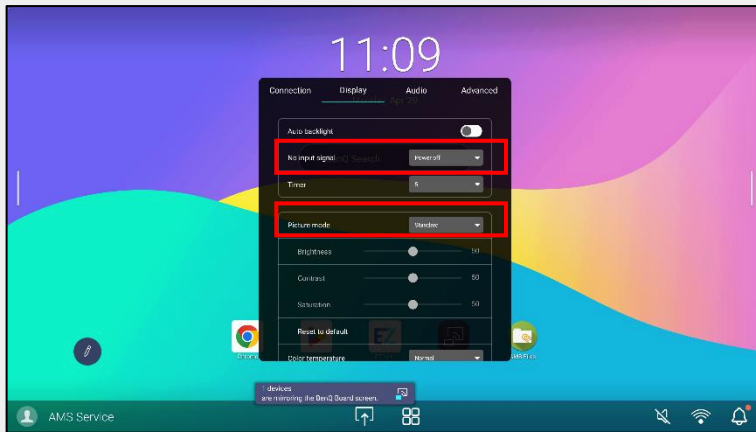

3. On the Advanced tab, select "Power & Sleep", and turn off the "power-off timer".

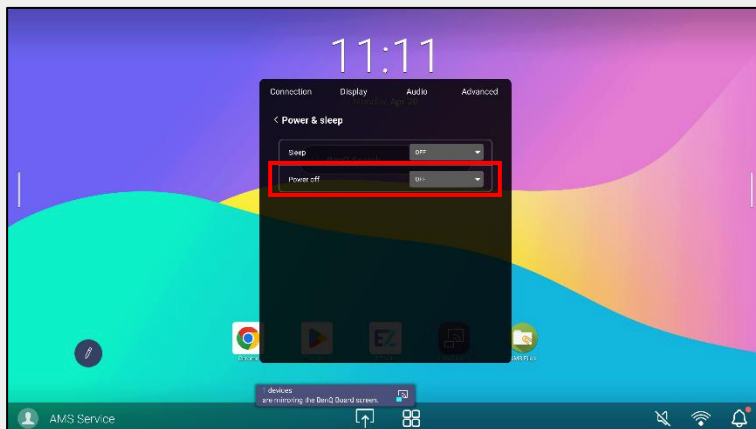

Recommend Setting

1.From the EZWrite 6 home screen, select “Settings” from the menu.

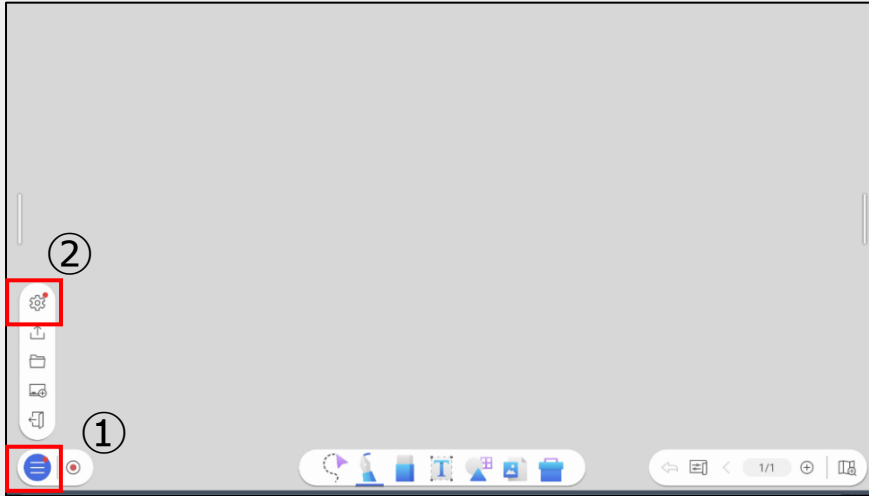

2.Under “Current Version of Settings,,” select “Update.”

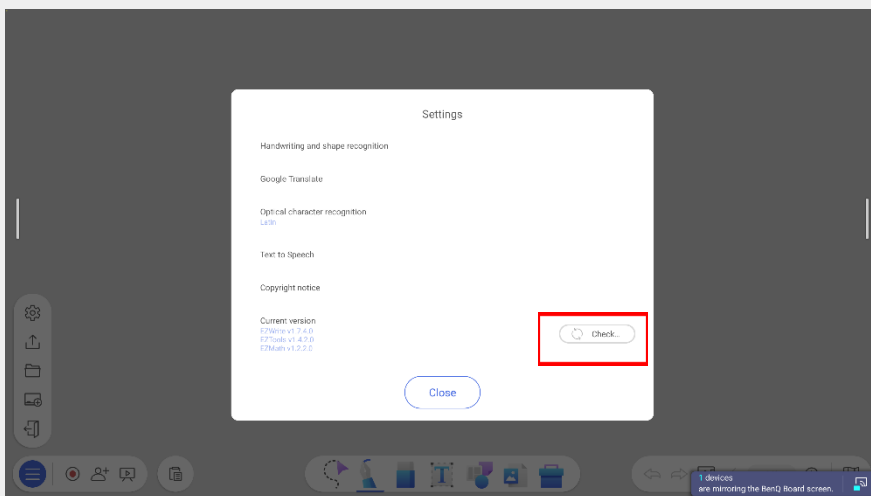

3.Download the latest version of EZWrite 6.



Recommend Setting

1. Select the handwriting recognition language from the menu on the EZWrite 6 home screen > Settings.

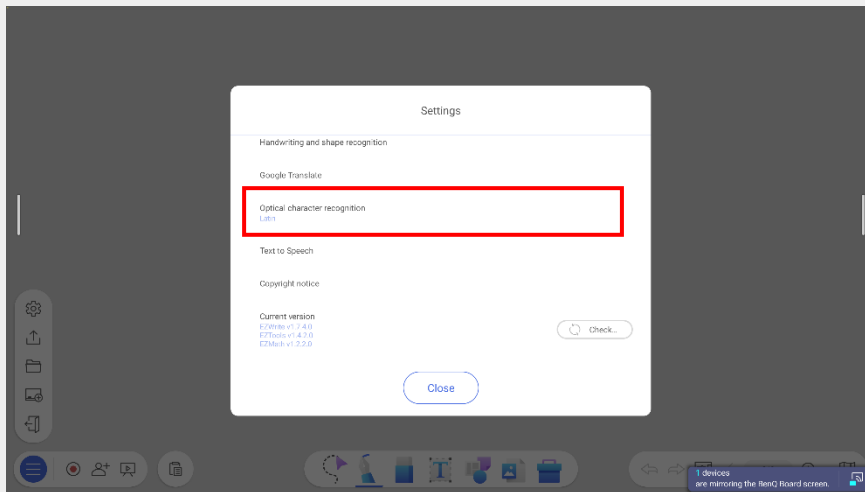

2. Click + icon to select a language you want to add for "Handwriting Recognition".

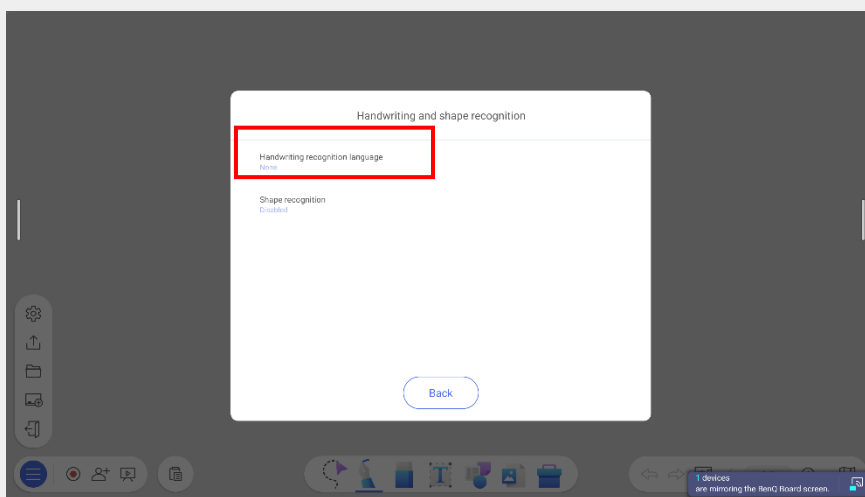

3. The downloaded language will be added. (See page 50 for details.)

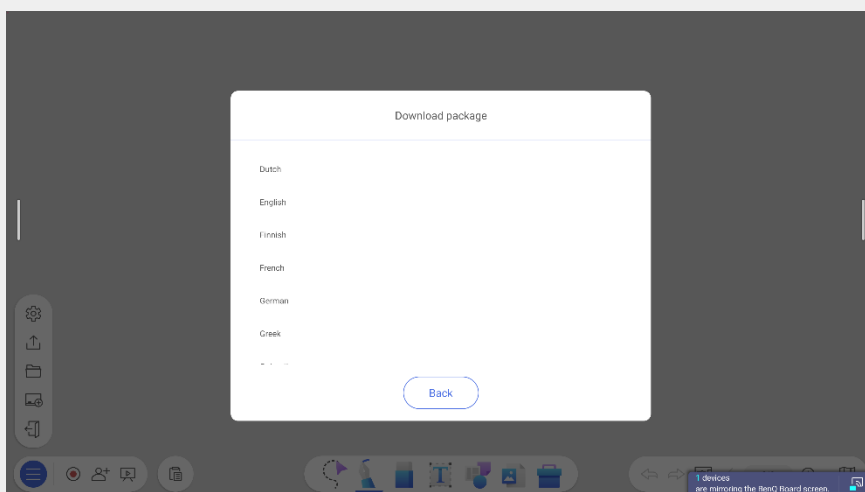

<How to use ①>

Mirroring Device Screen with Cables

Connecting BenQ Board and Device

1. Three ways to open the input-source-switching screen.

Method①: Select the input source icon at the bottom of the screen.

Method② Select the Settings button on the BenQ Board unit or the Settings option on the remote control.

Method③: Select "Connection" from the BenQ Board sidebar.

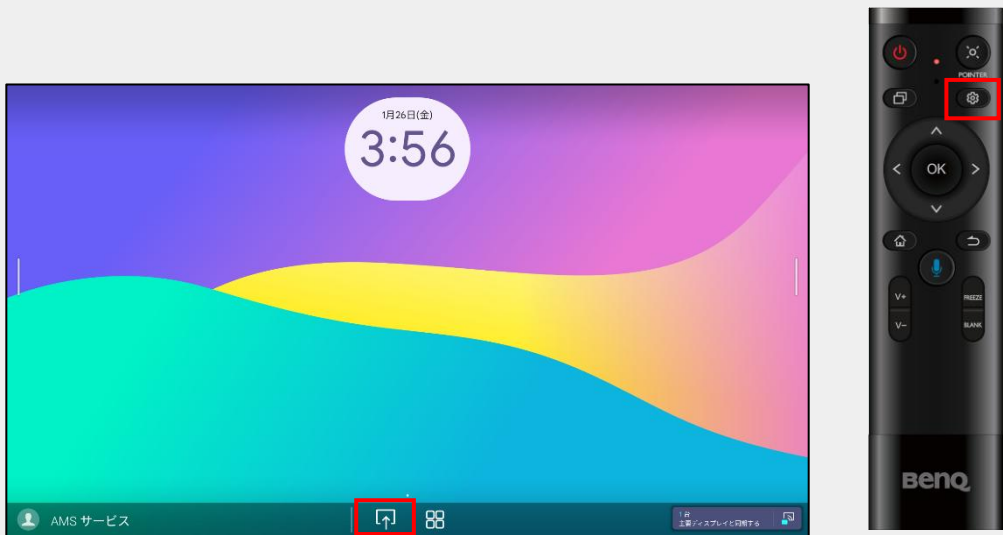

2. Tap twice on the input source from the "Connection" to switch screens.

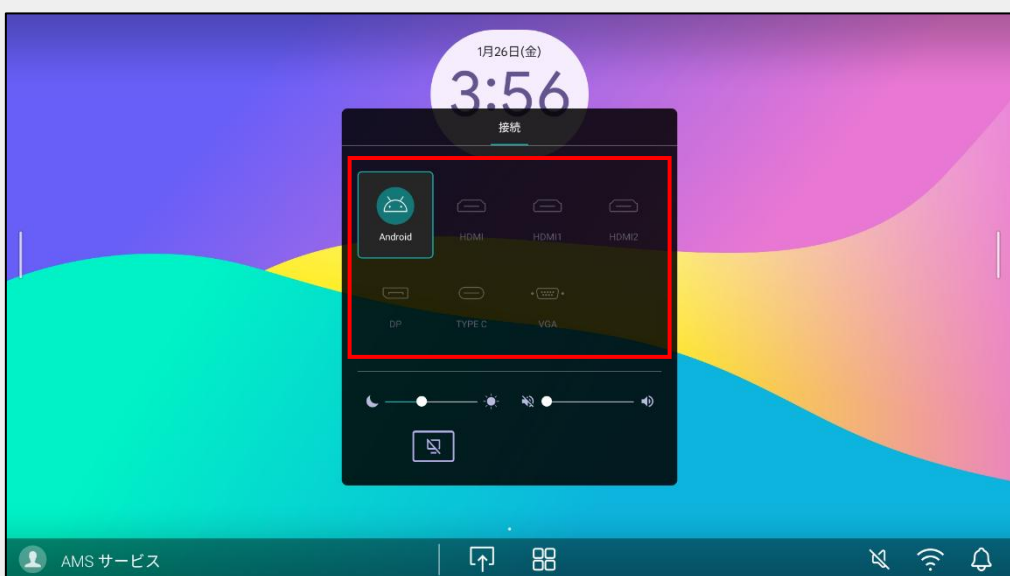

Connecting BenQ Board and Device

Method① With USB Type-C cable

Video/audio output, touch function, and Device power supply are available.

*Both USB Type-C cable and USB Type-C port on your PC must support DisplayPort functionality.

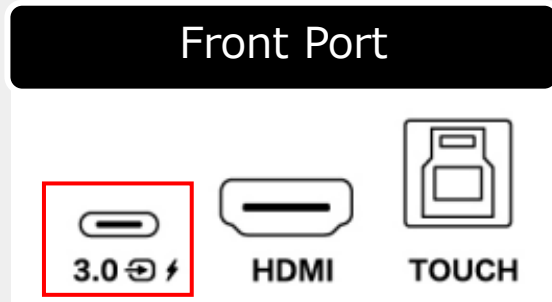

Method② With HDMI and touch cables

Video/audio output and touch functions are available.

*Use both HDMI cable and USB Type-B cable (for touch) to connect to HDMI port and USB Type-A port of your PC.
(If only HDMI cable is connected, only video/audio output will be provided)

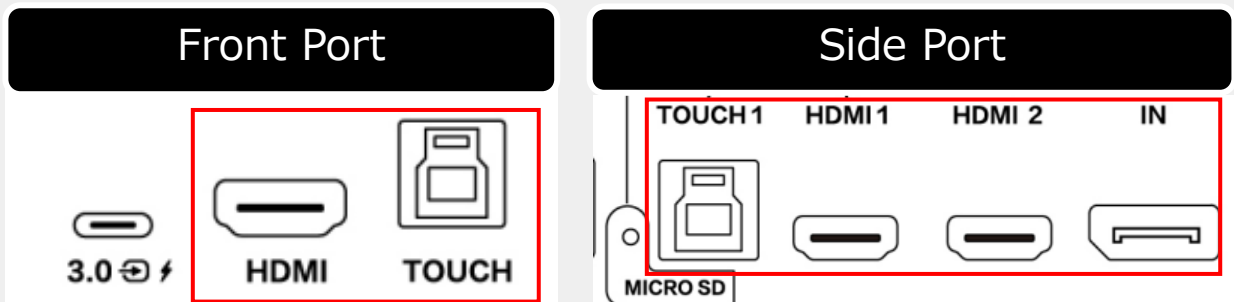

<Support OS> Windows OS, mac OS, Chrome OS, Linux OS

*Multi-touch may not be available depending on the model and OS version

EZ Floating Tool

To launch EZ Floating Tool, press and hold with two fingers on the screen. Then you can write annotations and more.

*Make sure EZ Float Tool is turned on from Settings →System.

*Not available when whiteboard app "EZWrite 6" is running.

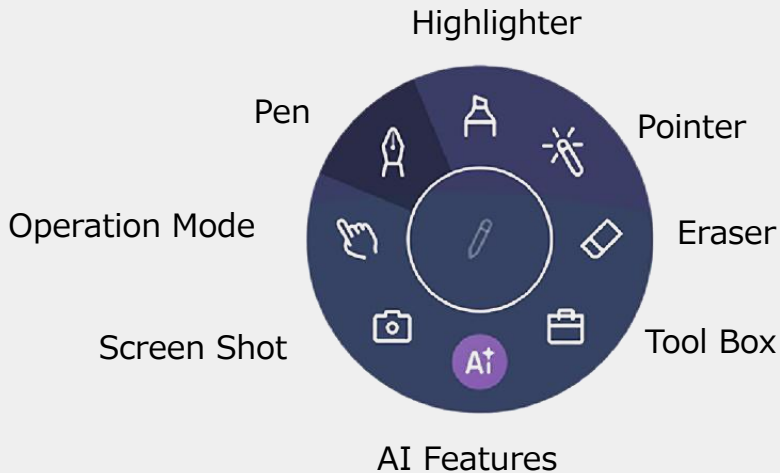

e.g.①



Use the spreadsheet app in BenQ Board to add annotations.

e.g.②

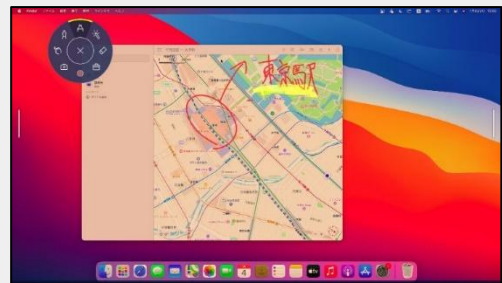

Connect MacBook to BenQ Board with USB Type-C (or HDMI) cable, then write notes on the screen.

How to keep EZ Floating Tool always visible

In the EZWrite 6 settings, activate "Keep Floating tool on screen" so that the EZ Floating Tool is always visible.



< How to use ② >
Wireless Mirroring

Wireless Mirroring App InstaShare 2

InstaShare 2 is an application to share the screen between your smartphone or PC and your BenQ Board.

Connection Methods

- AirPlay
- Google cast
- InstaShare2 app

* Using same network is required for both your devices and your BenQ Board

* This service may not be available depending on your network environment

< Launch screen sharing application (InstaShare 2) >

From the app list, select InstaShare 2 icon.

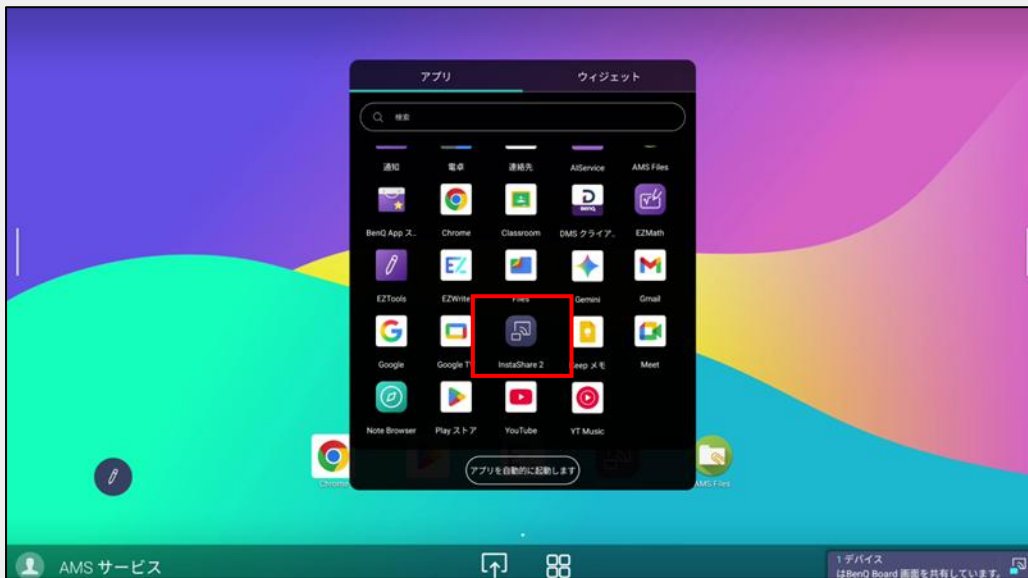

InstaShare2 Home Screen will be displayed.



Use AirPlay to mirror screen

Mac

1. Open the Control Center from the top of the screen.



2. Select Screen Mirroring and Select BenQ Board.



iPad, iOS

1. Swipe down from the top of the screen to open the Control Center.



2. Select Screen Mirroring and Select BenQ Board.



Use Google cast to mirror screen

1. Open Chrome browser.

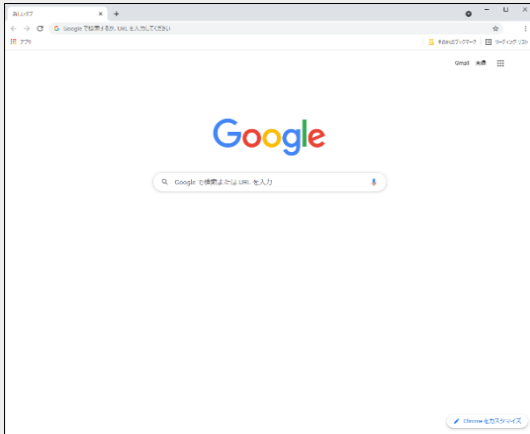

2. Select "⋮" in the upper right corner of the browser.

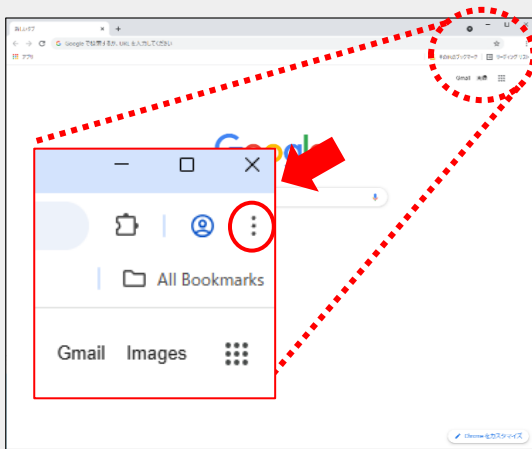

3. Select "Cast" from the Cast, Save, and Share options.

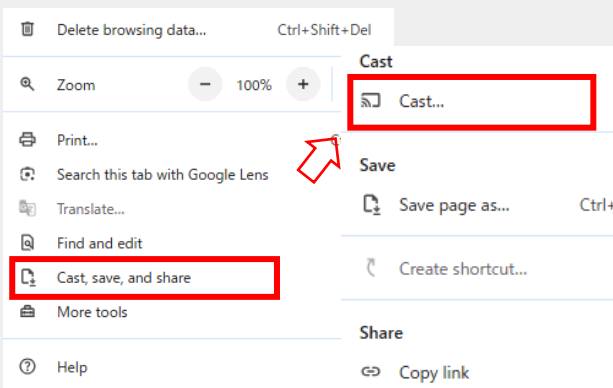

4. Select "Source", then select "Cast Desktop" or "Cast Tab", then Select the BenQ Board.

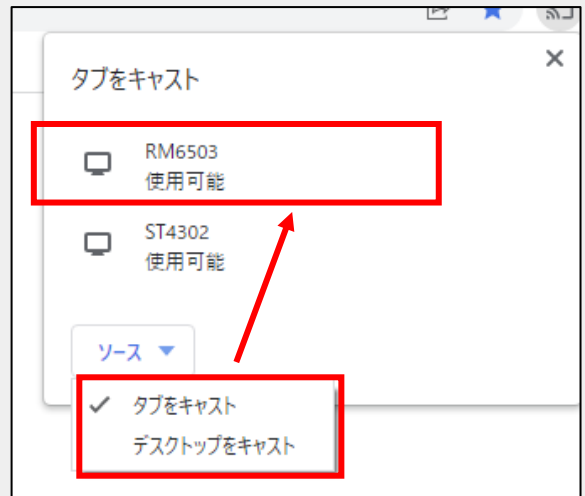

5. The status changes to "Casting in progress" and the mirroring will start.



6. To stop the mirroring, select the BenQ Board in the list.

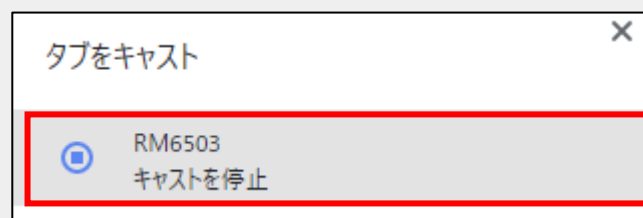

How to use InstaShare 2 App

< Install InstaShare 2 App >

- **For Windows or Mac**

Download and install the InstaShare2 application from the BenQ website.

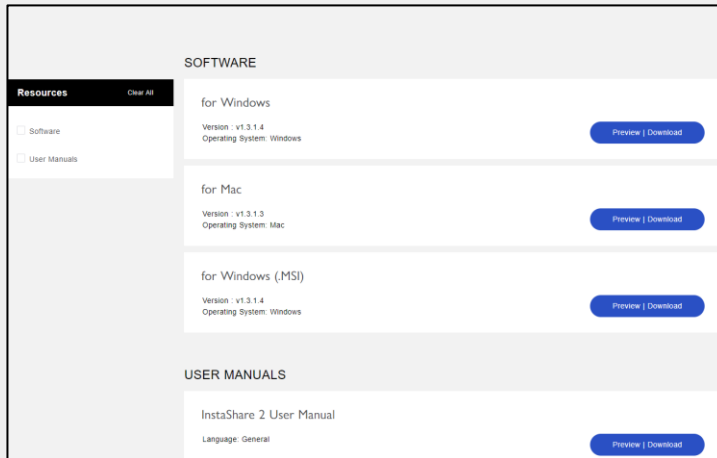

- **For Android or iPad, iOS**

Download InstaShare 2 from Google Play or App Store Install InstaShare2.



Screen Mirroring (InstaShare 2)

Windows PC, Mac PC

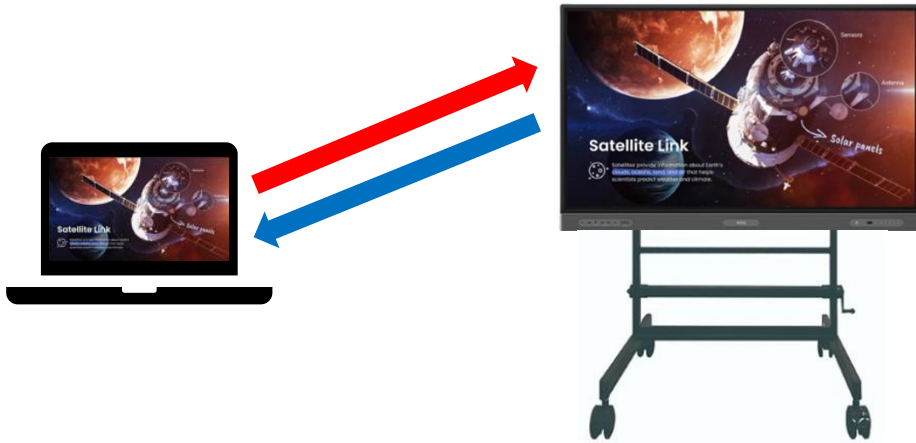

PC screen to BenQ Board



BenQ Board screen to PC

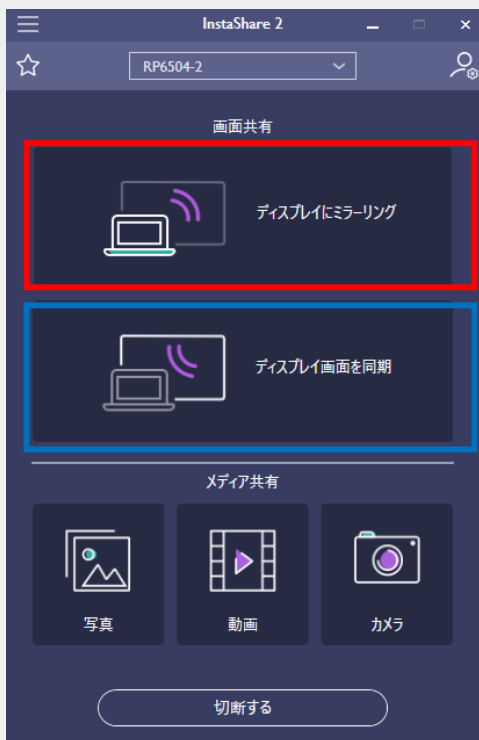
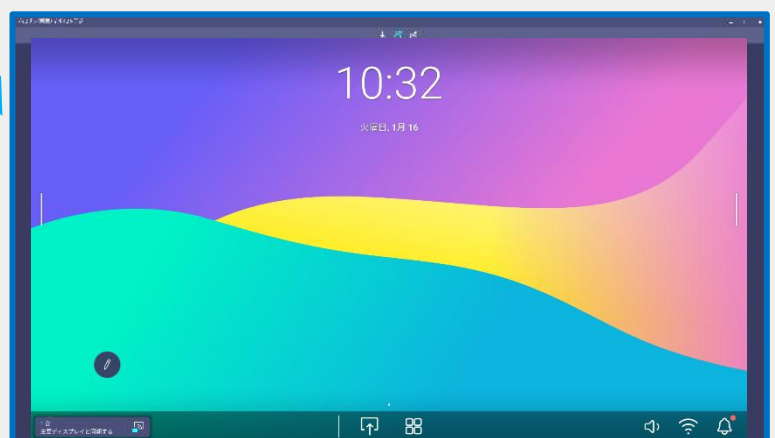

Screen Mirroring (InstaShare 2)

Android、iPad、iOS

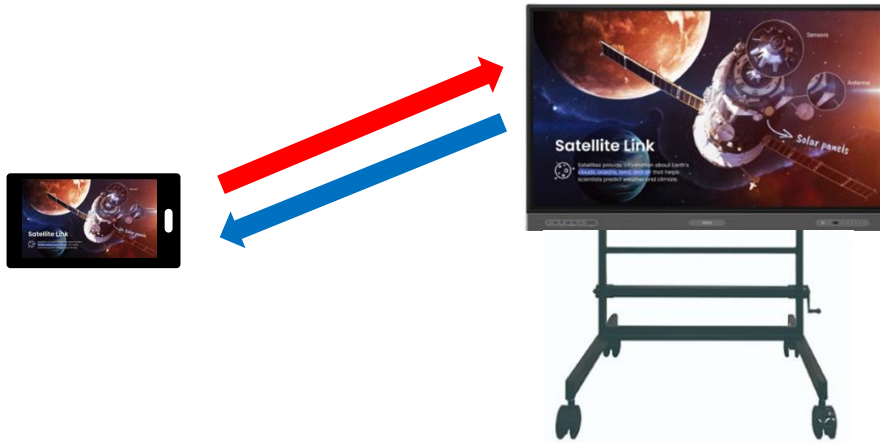

PC screen to BenQ Board

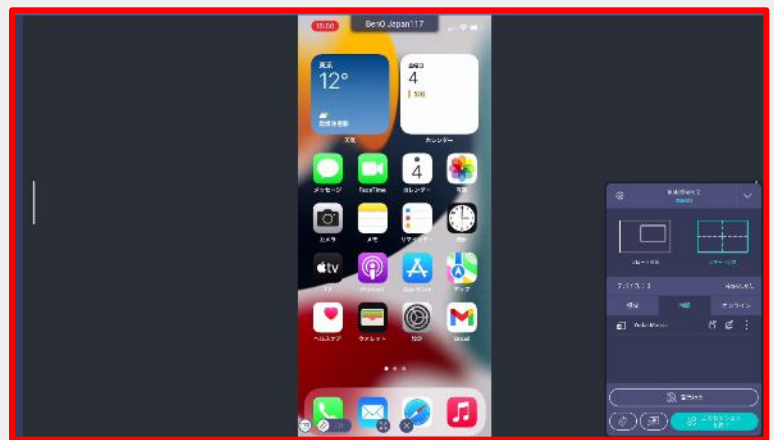

BenQ Board screen to PC



Screen Mirroring (InstaShare 2)

• Annotation

You can add annotations and other notes using the pen icon in the Instashare 2 menu.

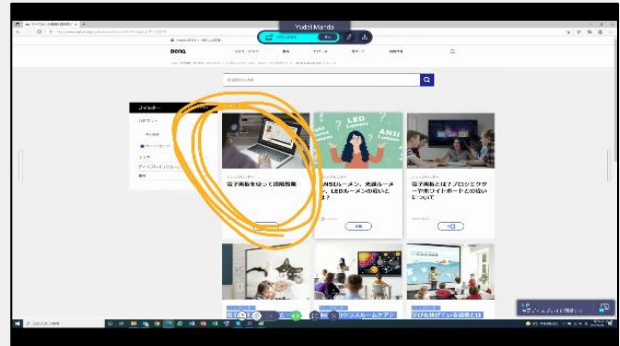

*EZ Floating Tool is also available for annotation writing.

• Touch operation

For Windows PC , Mac PC



Touch operation is available **both from your device and from your BenQ Board**

For Android, iPad, iOS



Touch operation is available **only from your device.**

< How to use ③ >

Whiteboard App

Whiteboard App (EZWrite 6)

EZWrite 6 is a whiteboard application preinstalled on the BenQ Board.

*Please download the Windows and Mac versions from the BenQ website.

< Start whiteboard application (EZWrite) >

Select EZWrite 6 from the list of applications.

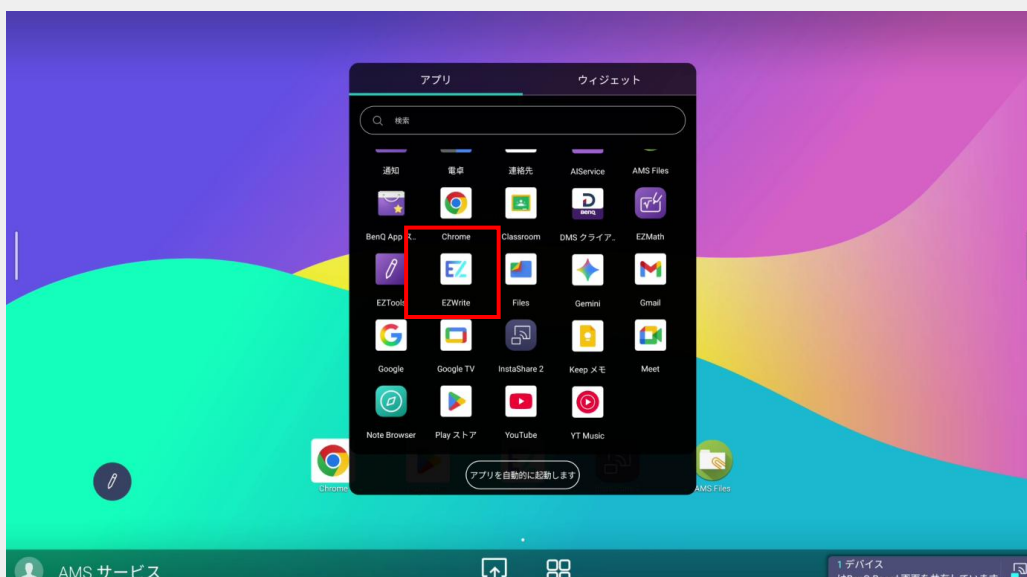

Open whiteboard app.

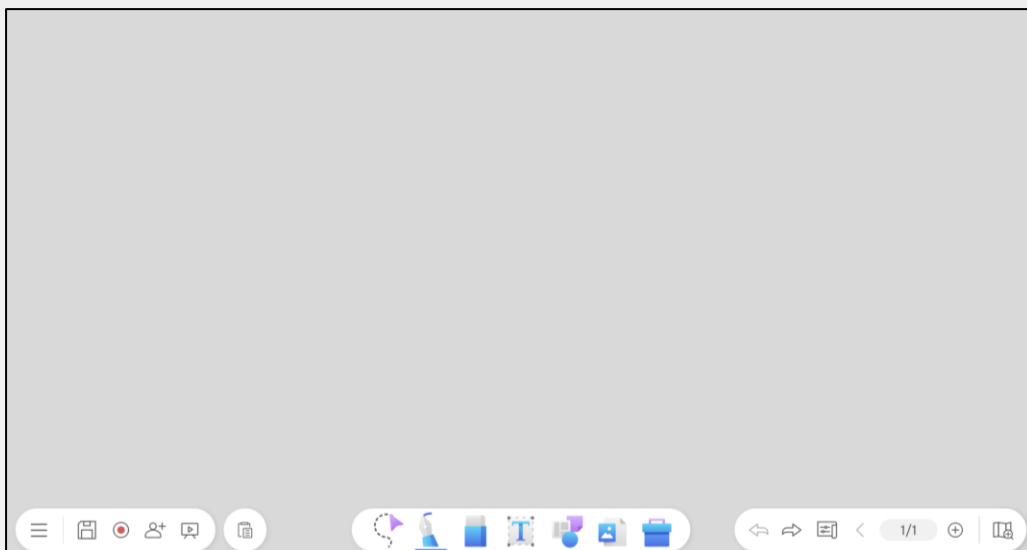

Selection Tool

When you select the Selection Tool from the toolbar, you enter "Selection Mode." You can select and resize objects with a single tap, and zoom in and out of the whiteboard page using two fingers.

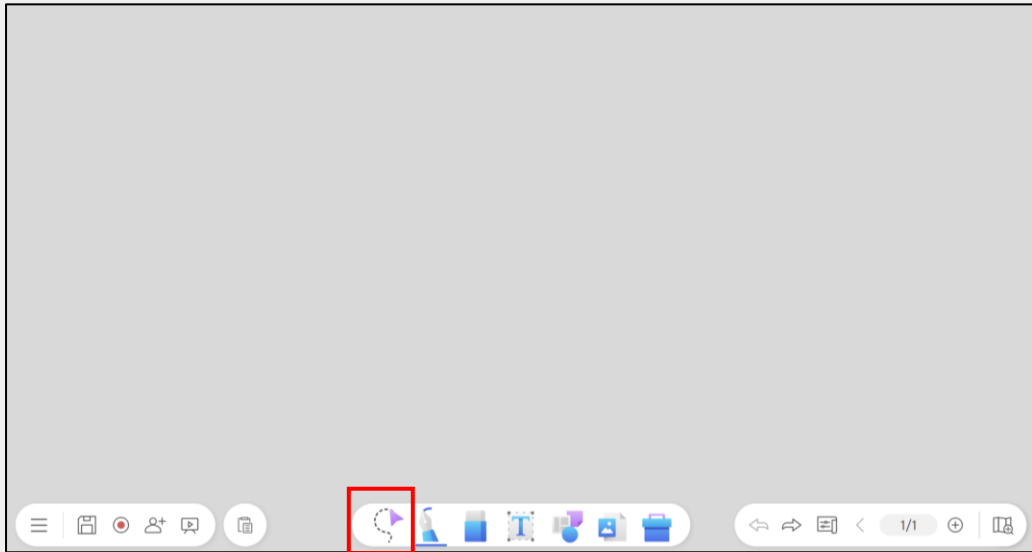

Zoom in/out

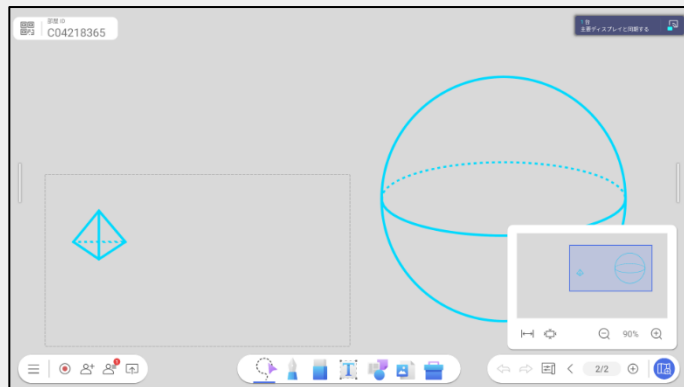
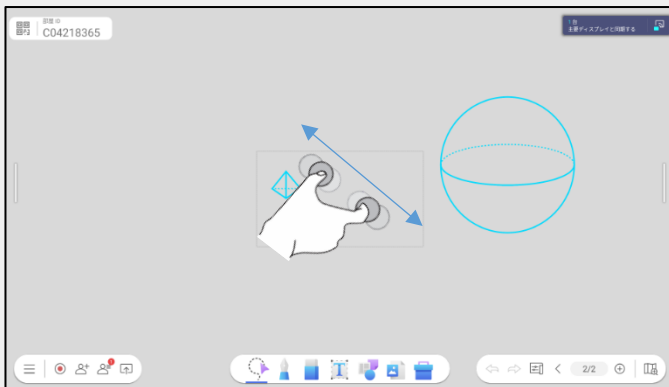

Object Selection

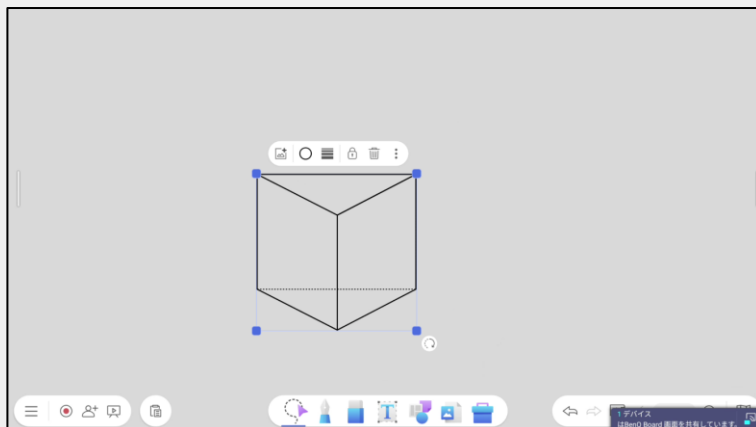

Pen

You can write by selecting the pen icon on the toolbar.

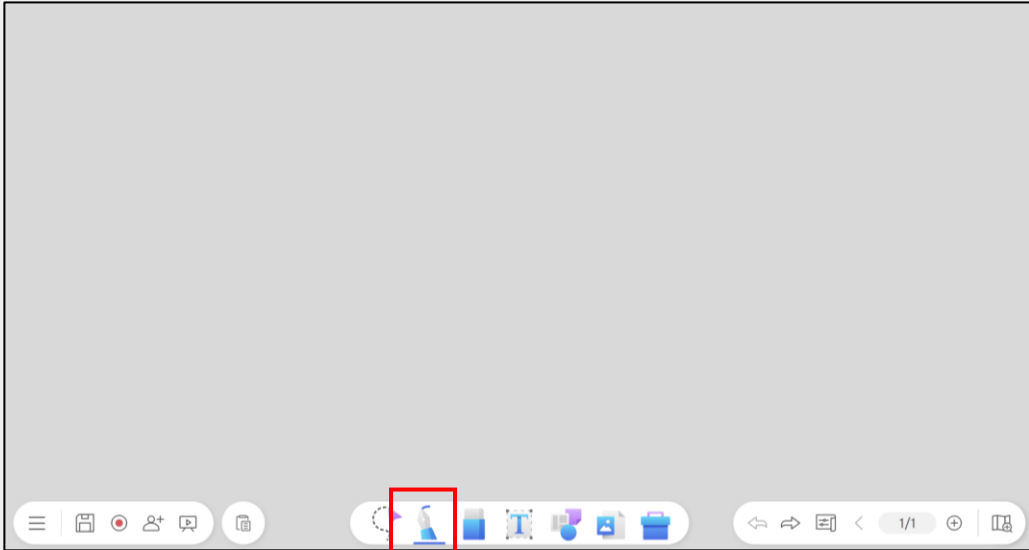

Tapping the pen icon twice opens the pen settings screen, where you can change the color and thickness, switch pen modes, and register custom colors.

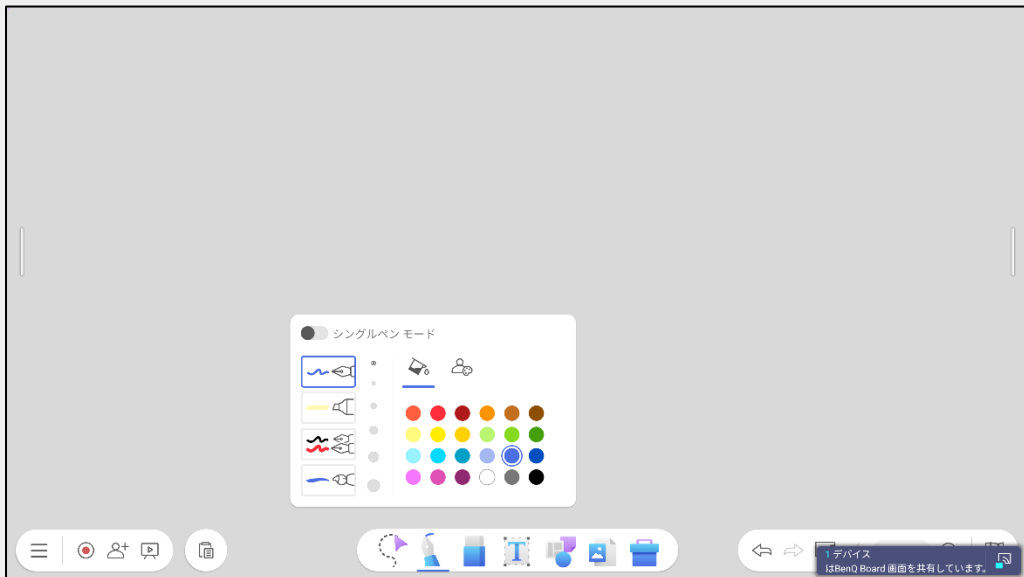

Pen . . . You can write here.

Highlighter . . . You can emphasize it without filling it in.

Dual Pen . . . You can use two different colors by switching between the pen's different tip sizes.

Brush . . . You can vary the thickness by using a brush or similar tool.

* When you enable Single Pen Mode, you can write with a fine pen tip and use the eraser with a thick pen tip.

Eraser

< Method 1 >

Tap eraser icon on the toolbar to select one of three erasers.

- **Finger eraser:** This deletes the selected portion.
- **Stroke eraser:** You can erase everything you've written in a single stroke.
- **Erase all:** This clears what you've written on the page.

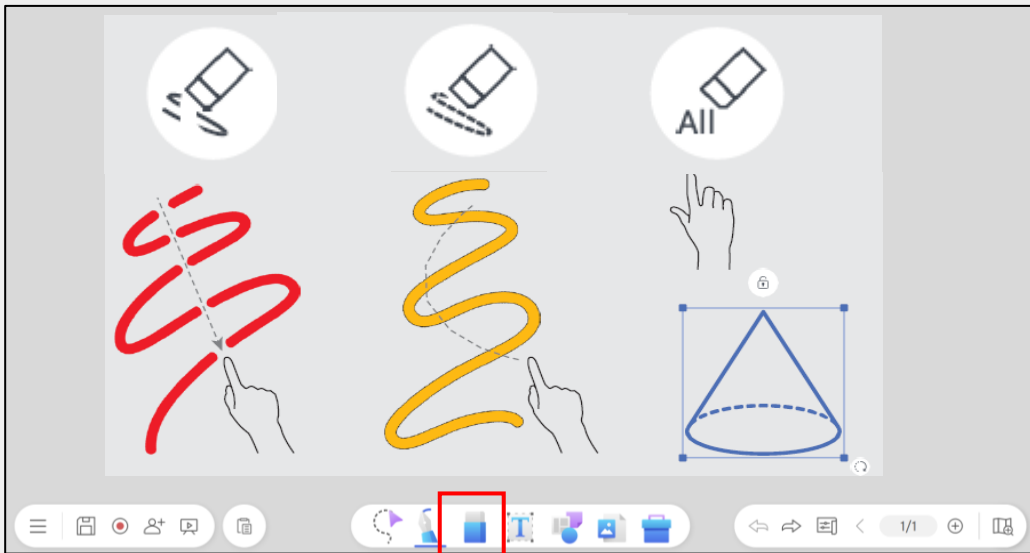

< Method 2 >

You can erase text written with a pen using your palm or the eraser tool.

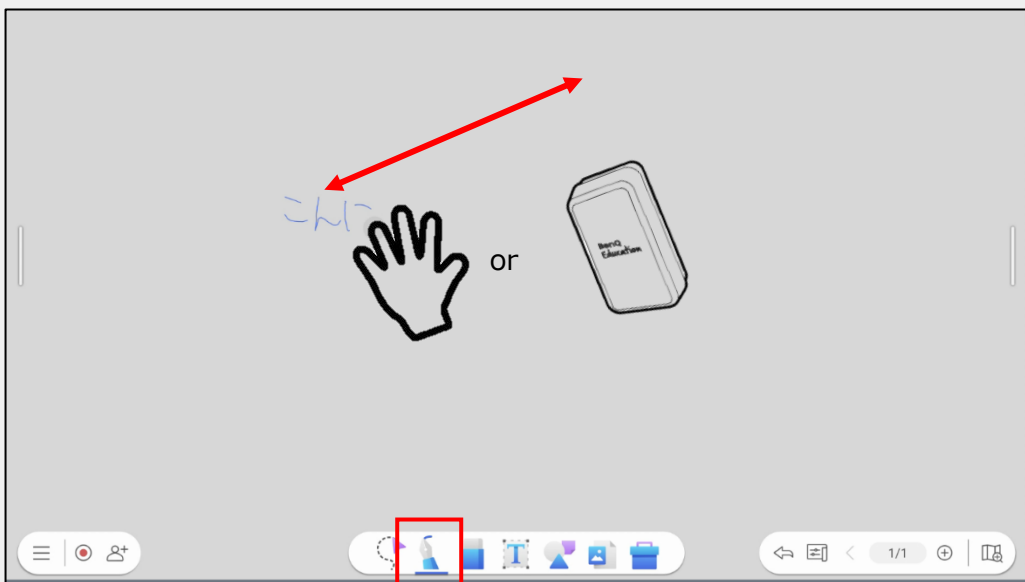

Palm eraser is available when pen mode is selected.

Text

Select the text box icon on the toolbar to enter text.

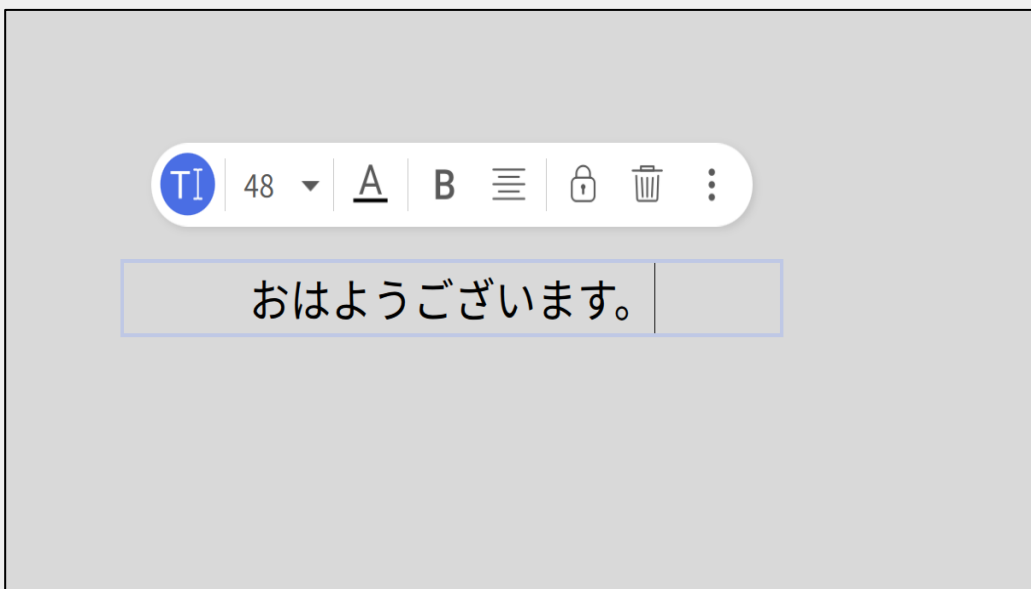
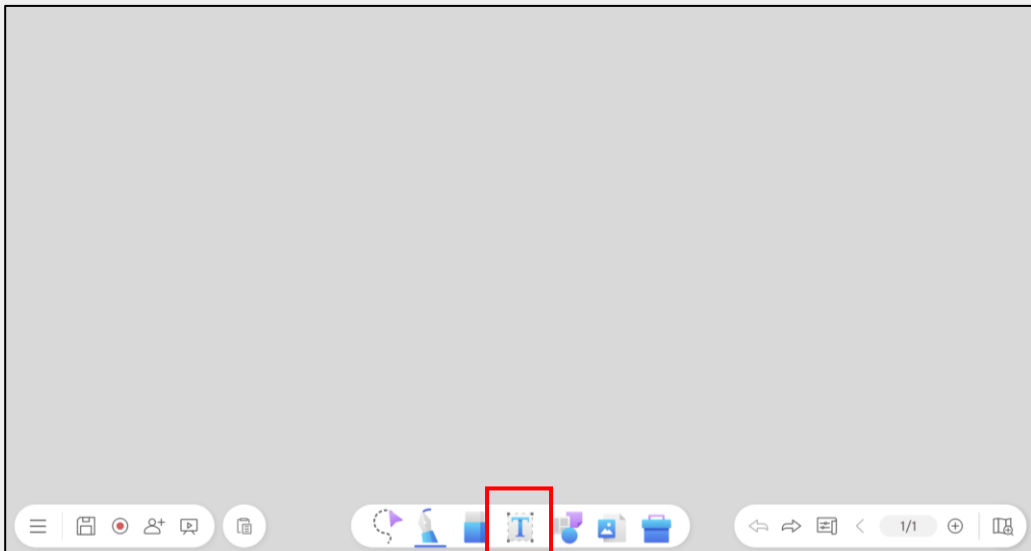

Shapes and Template

By selecting the shapes icon on the toolbar, you can insert sticky notes, shapes, 2D images, 3D images, and templates.

* Template list is available in English only.

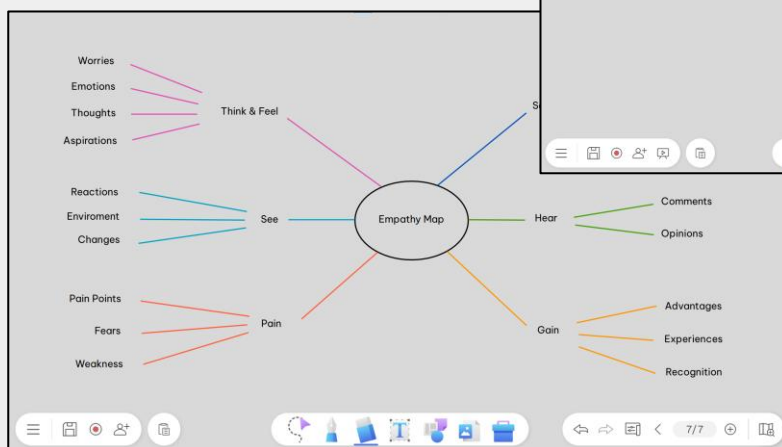
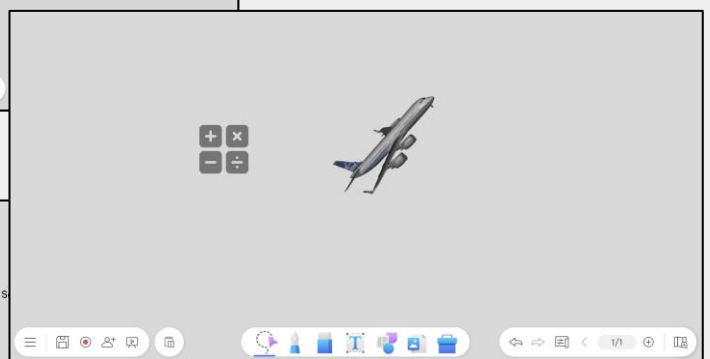
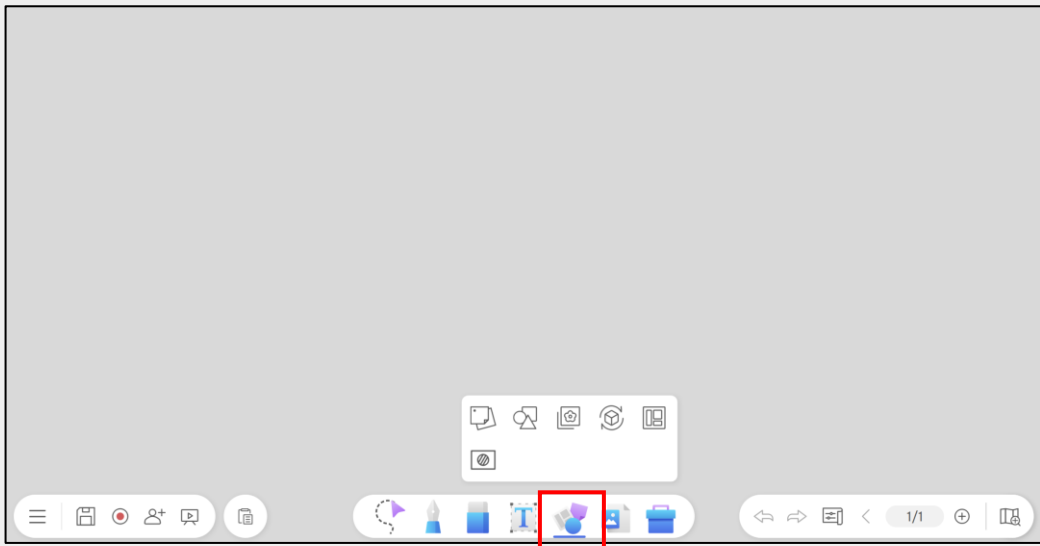

Import Media

By selecting the photo icon on the toolbar, you can insert camera images, image files, document files, EZWrite files, videos, music, web page links, YouTube links, Google Slides, and 3D images.

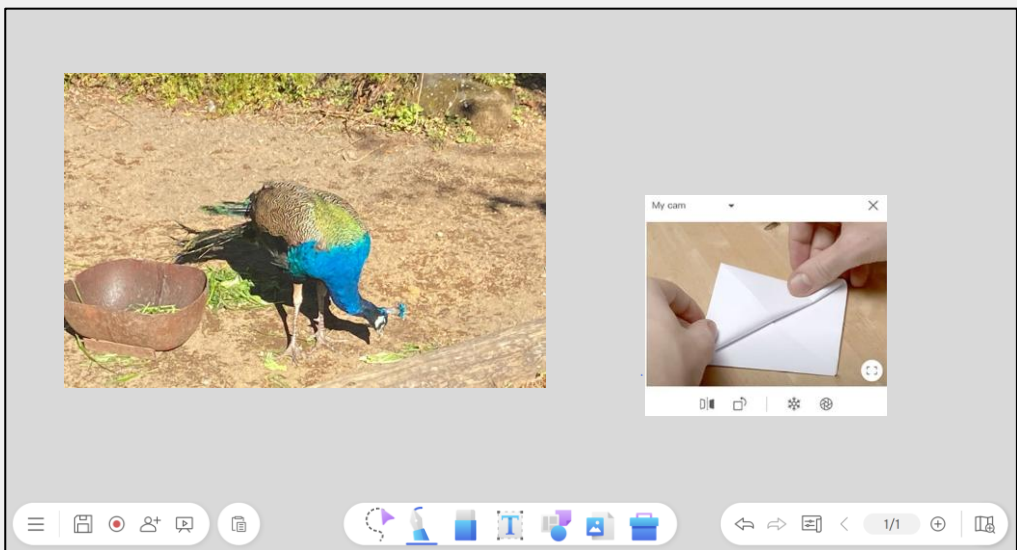
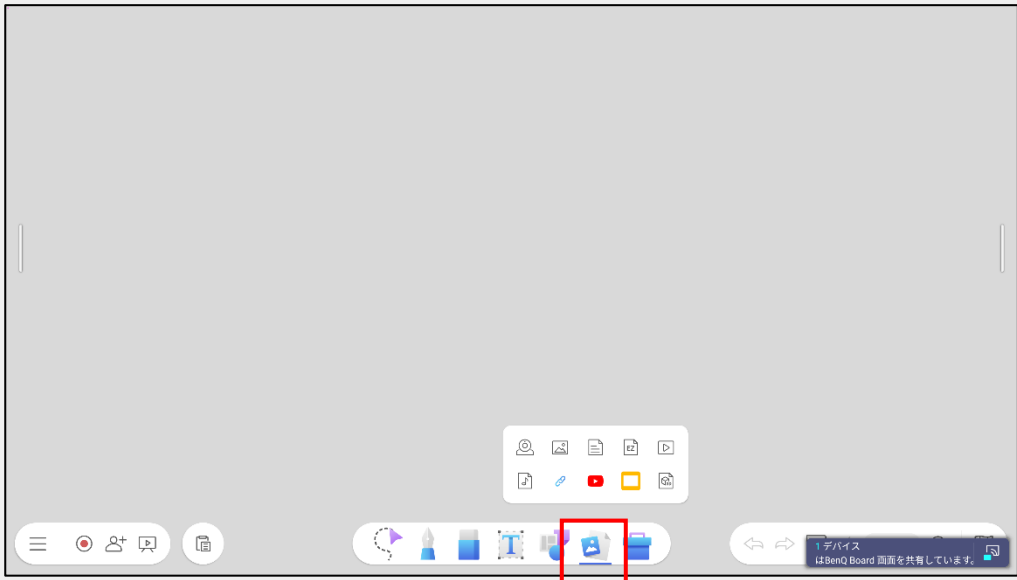

Control Objects

When an object is selected, you can move, lock, and delete the object.

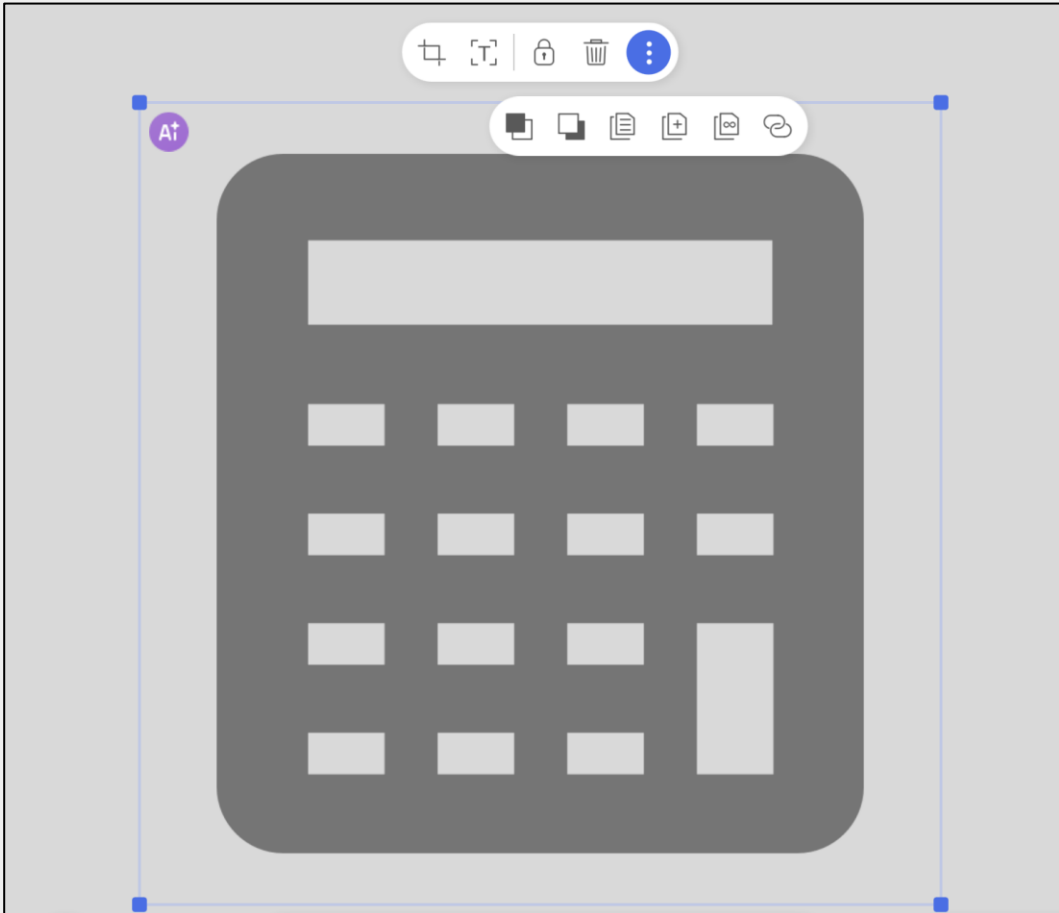

Trimming

Text Extraction

Lock

Delete

Show more



Bring to front, Send to back

Copy

Duplicate

Infinite Copy

Insert URL

Control Objects

By selecting the AI icon in the upper-left corner of the image, you can apply an artistic filter to the image or remove the background.

Artistic style

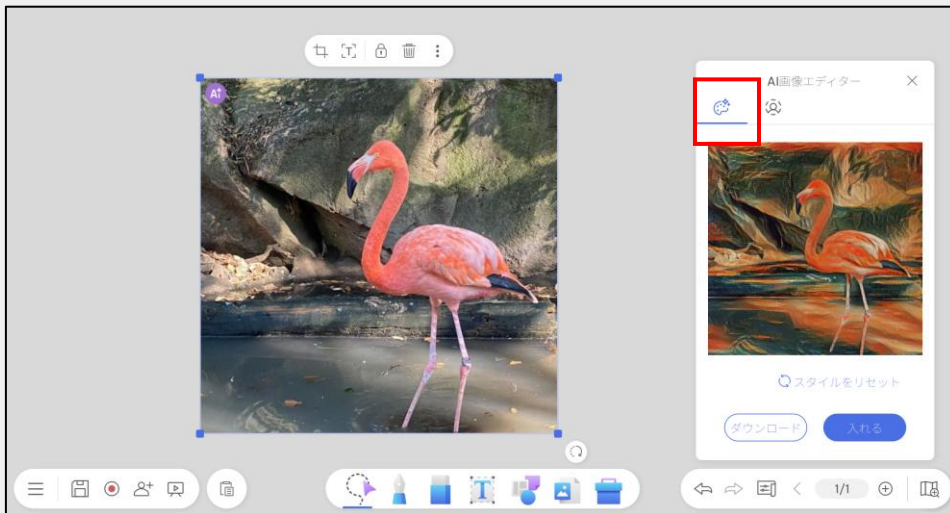

Remove the background image

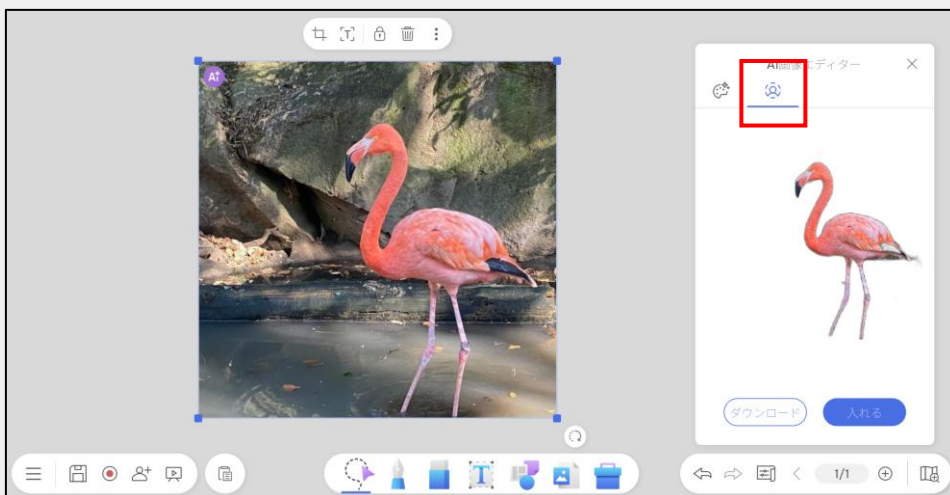

Tool box

When you select the toolbox icon on the toolbar, you can access the ruler, protractor, compass, set square, calculator, unit converter, handwriting calculator, timer, stopwatch, scoreboard, random number generator, team posting feature, roulette, slide mode, notes, Open Maps, Open Drive, Open Chrome, and Spotlight.

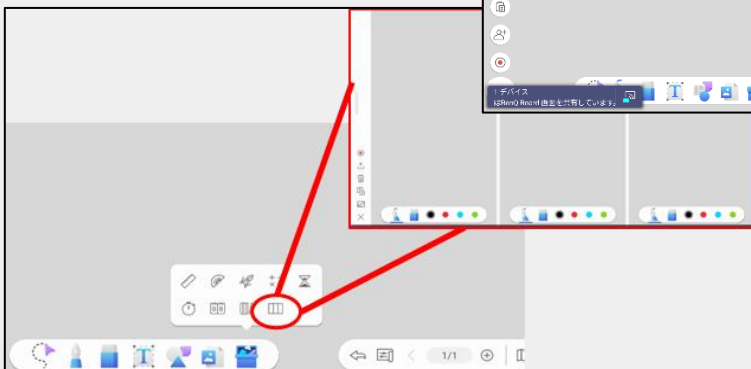
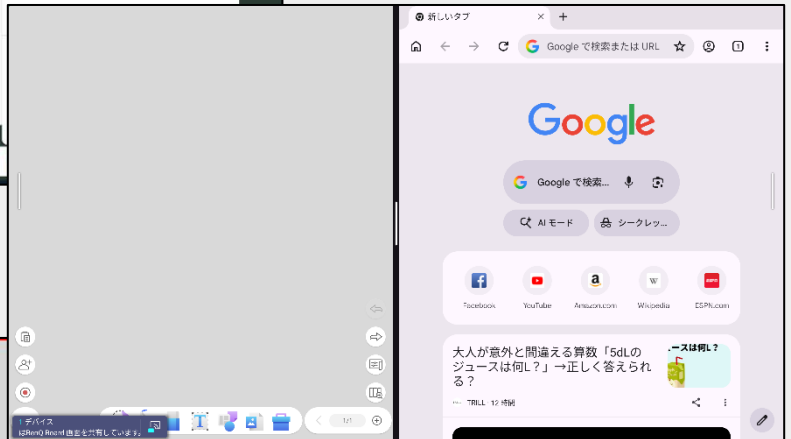
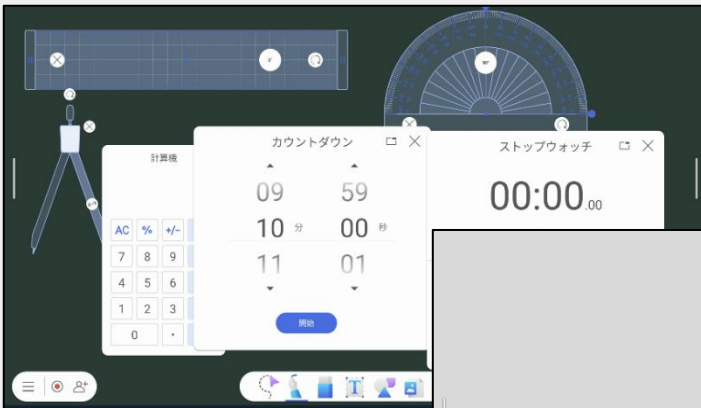
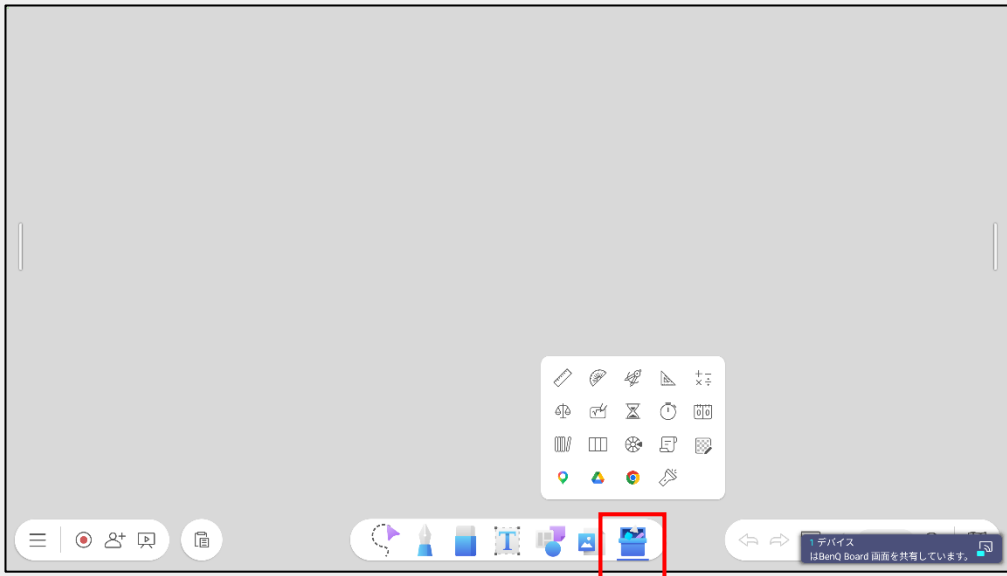

Handwriting Recognition

Tap "Select" icon, circle a handwritten text, then tap "ez" icon to converted the handwritten text to a text.

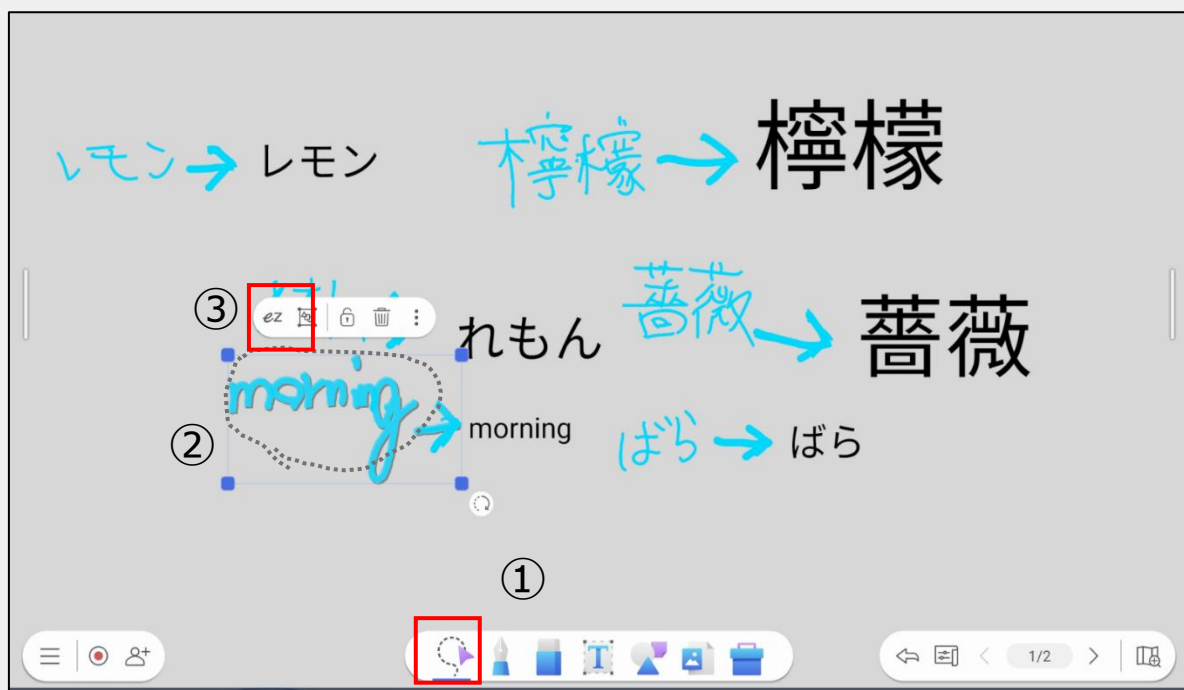





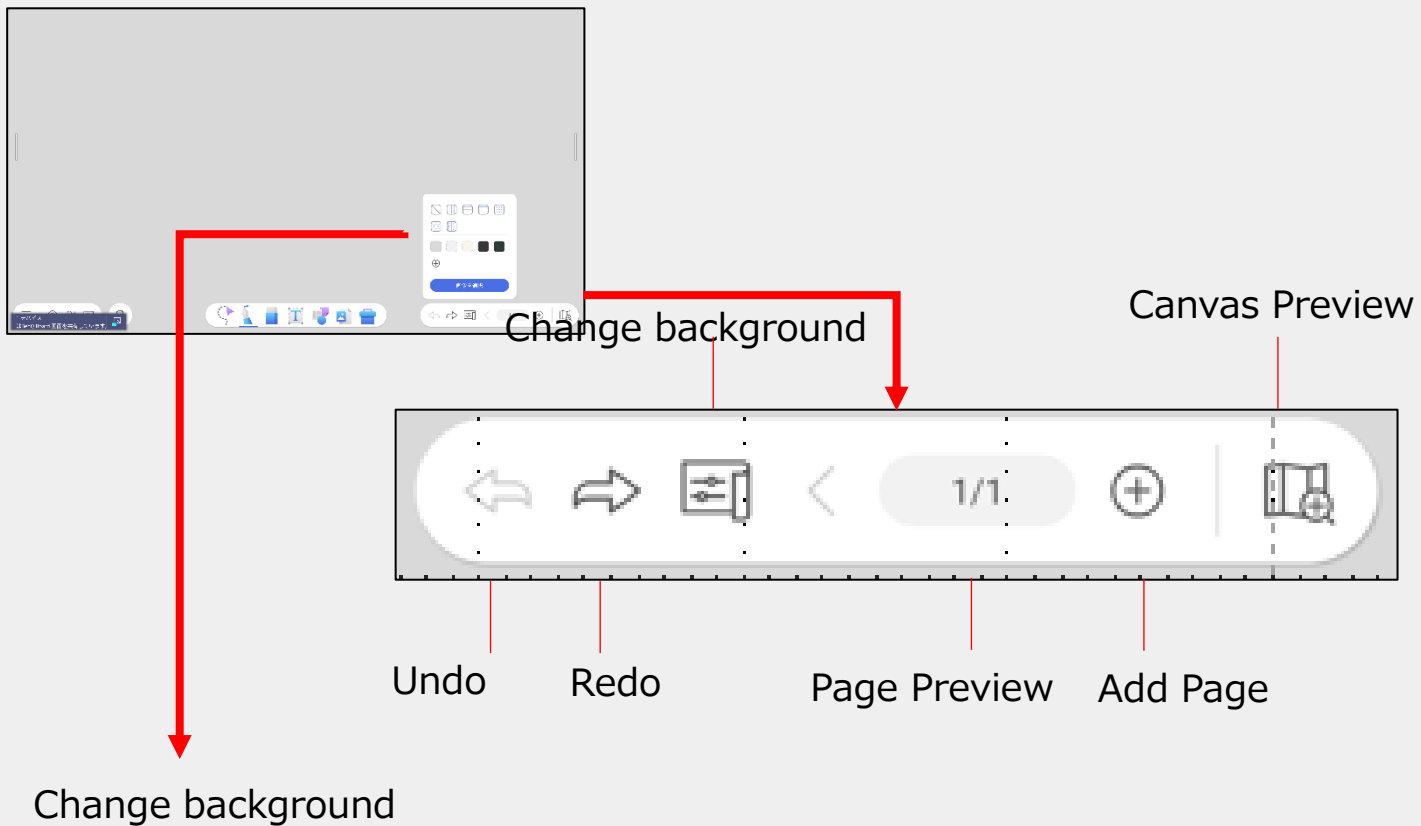

Index	Language	Index	Language
1	English	17	Portuguese
2	French	18	Traditional Chinese
3	German	19	Simplified Chinese
4	Dutch	20	Arabic
5	Polish	21	Japanese
6	Russian	22	Thai
7	Czech	23	Persian
8	Danish	24	Vietnamese
9	Swedish	25	Korean
10	Italian	26	Turkish
11	Romanian	27	Bahasa Indonesia
12	Finnish	28	Hebrew
13	Norwegian	29	Hindi
14	Greek	30	Catalan
15	Hungarian	31	Basque
16	Spanish	32	Spain(Basque)

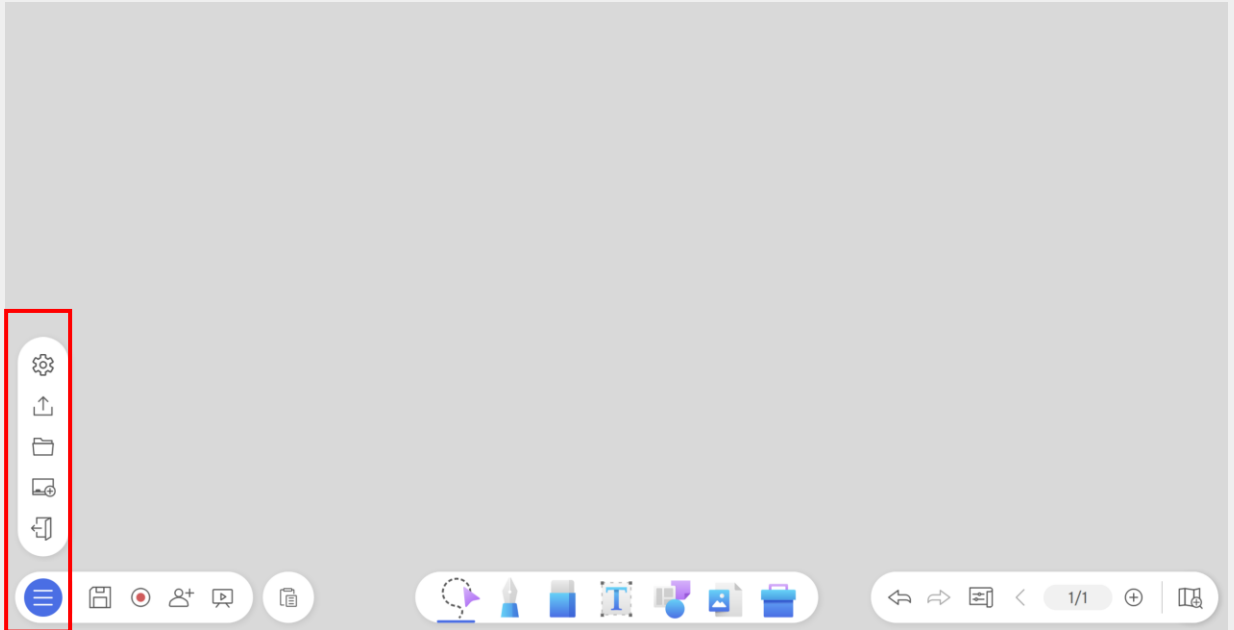
Navigation bar



Main Menu



-  EZWrite 6 setting
-  Save
-  Auto-saved whiteboard list
-  Open new whiteboard
-  Close EZWrite6

Save

From the Main menu → Save.

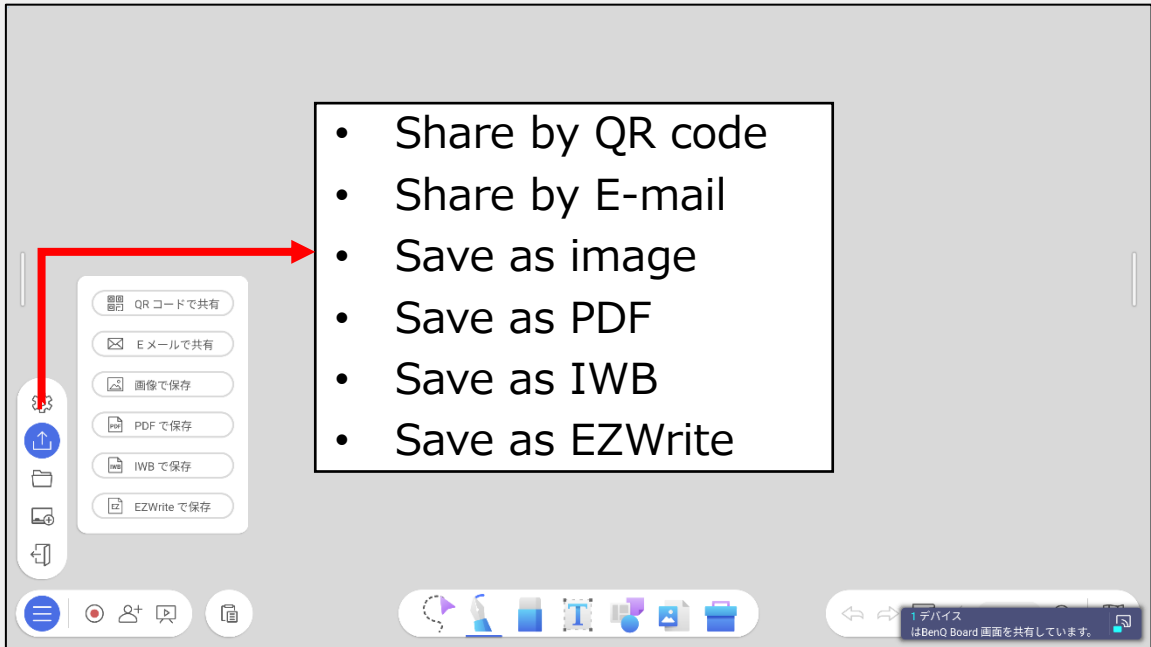

From the “Details” menu → “Autosaved Whiteboard List”.

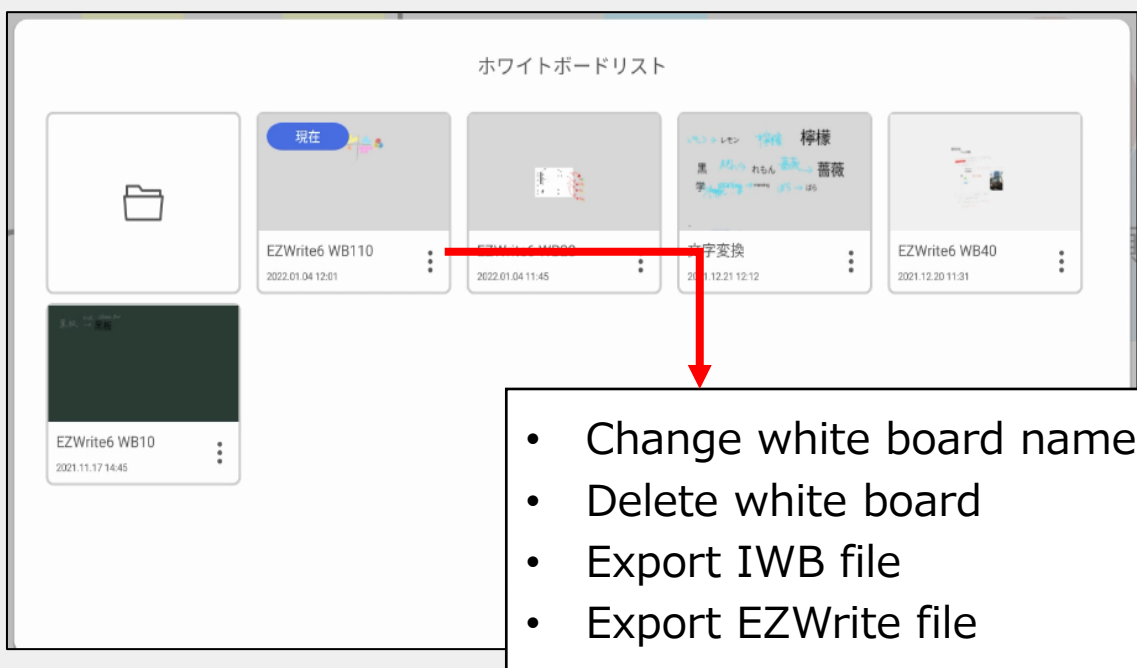

Reference Zone and Fit to Screen

In EZWrite 6 settings, "Show reference zone" can be enabled to show a border on the canvas. You can find the reference zone easily even when the canvas is zoomed out.

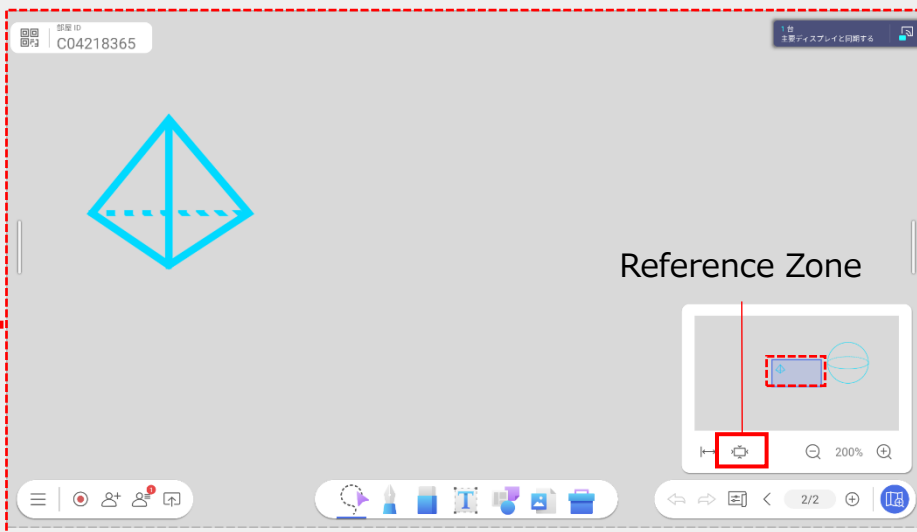

In EZWrite 6 settings, "Show reference zone" can be enabled to show a border on the canvas. You can find the reference zone easily even when the canvas is zoomed out.

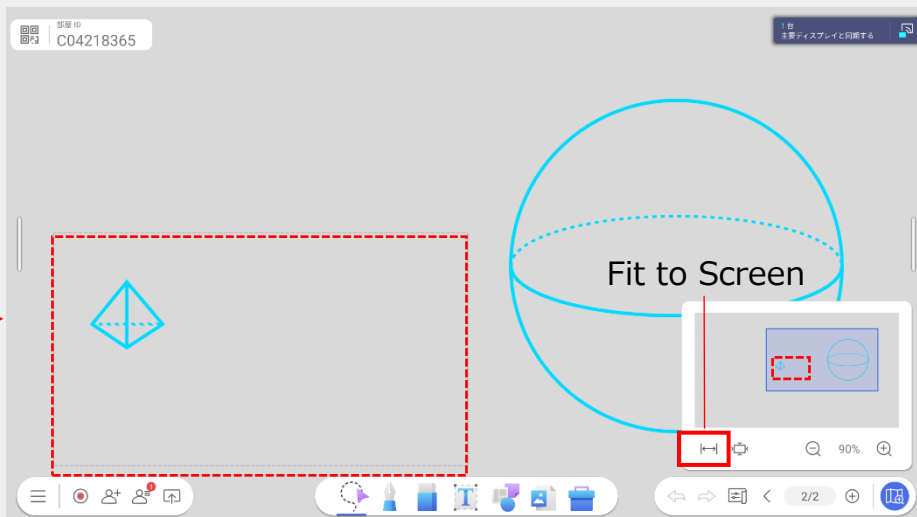

Cloud Whiteboard(Host)

With the Cloud Whiteboard, you can view and write on the whiteboard via a browser or other EZWrite apps, enabling handwritten communication with remote users.

< Support Browser> Chrome, Safari, Edge and Firefox

1. Select  icon and choose "Invite Members." Start the cloud whiteboard.

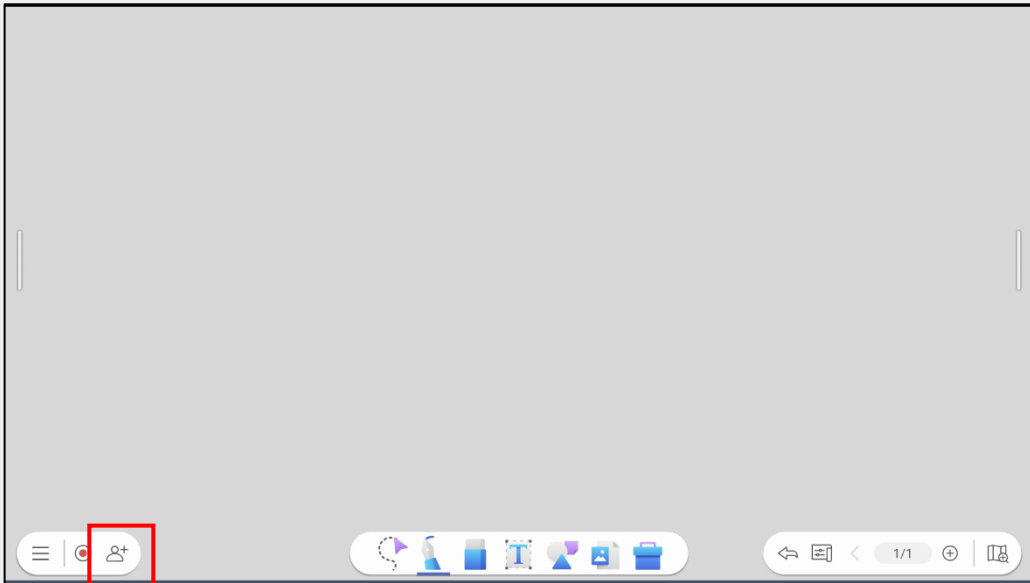

2. Participants can join by scanning the QR code and entering their name, or by entering the room ID into the displayed URL and entering their name.



Cloud Whiteboard(Guest)

1. Select "Join" for each account or as a guest.

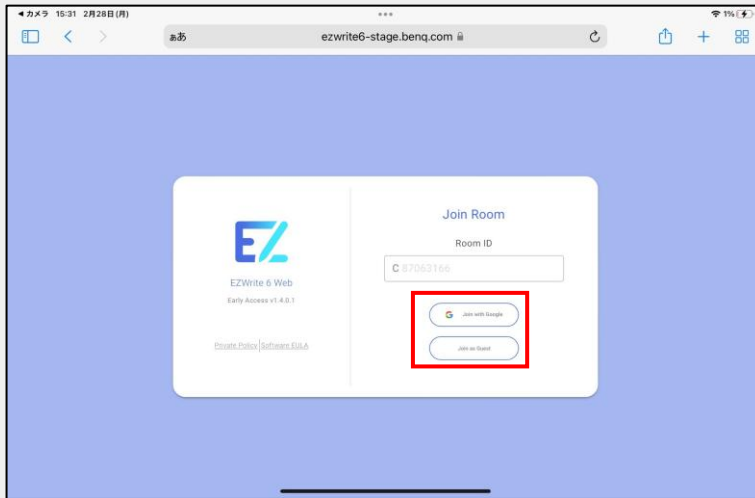

2. If you are joining as a guest, enter any name you like and select "Join."

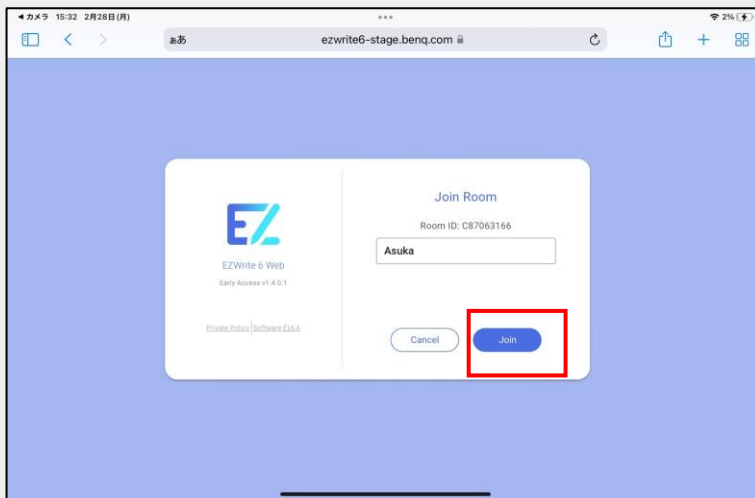

3. You will now see the cloud whiteboard screen.



Cloud Whiteboard Function

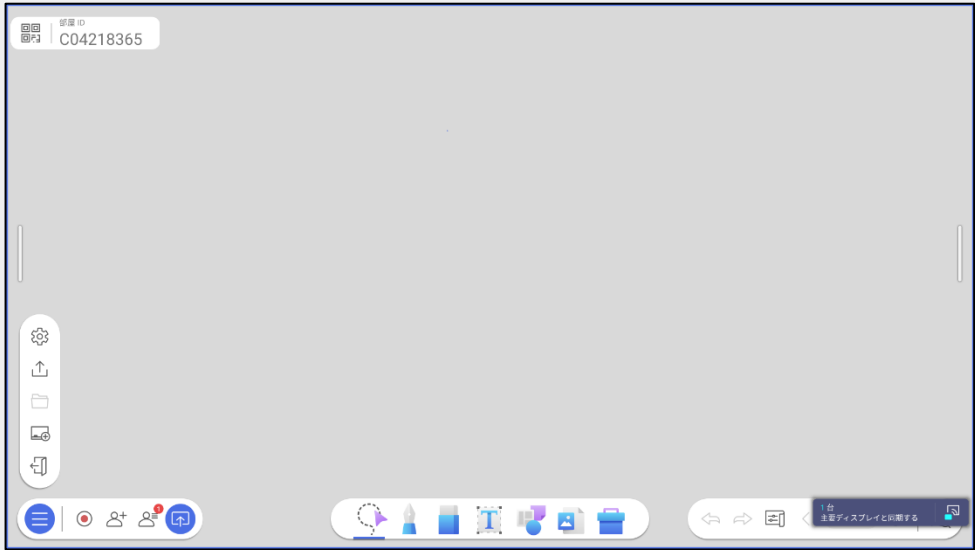

Display the invitation link again

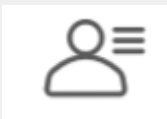
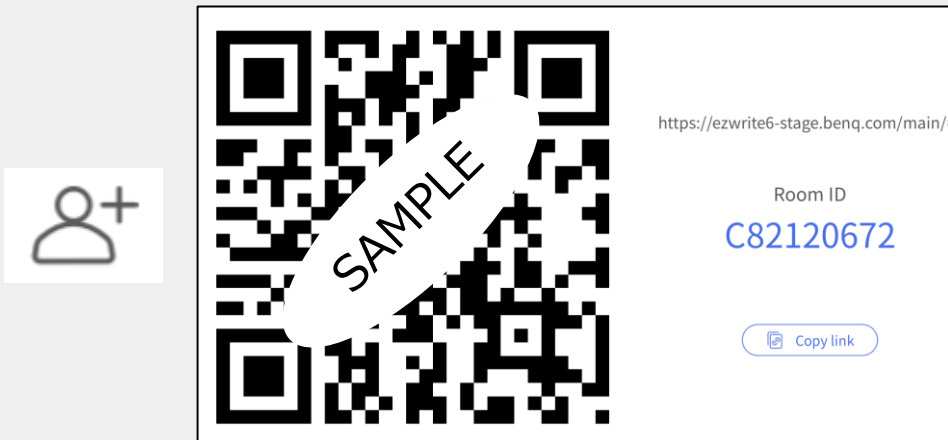

Display the list of participants

*See the next page for details

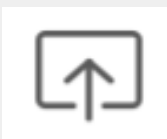

Sharing the host display area

Cloud Whiteboard Function

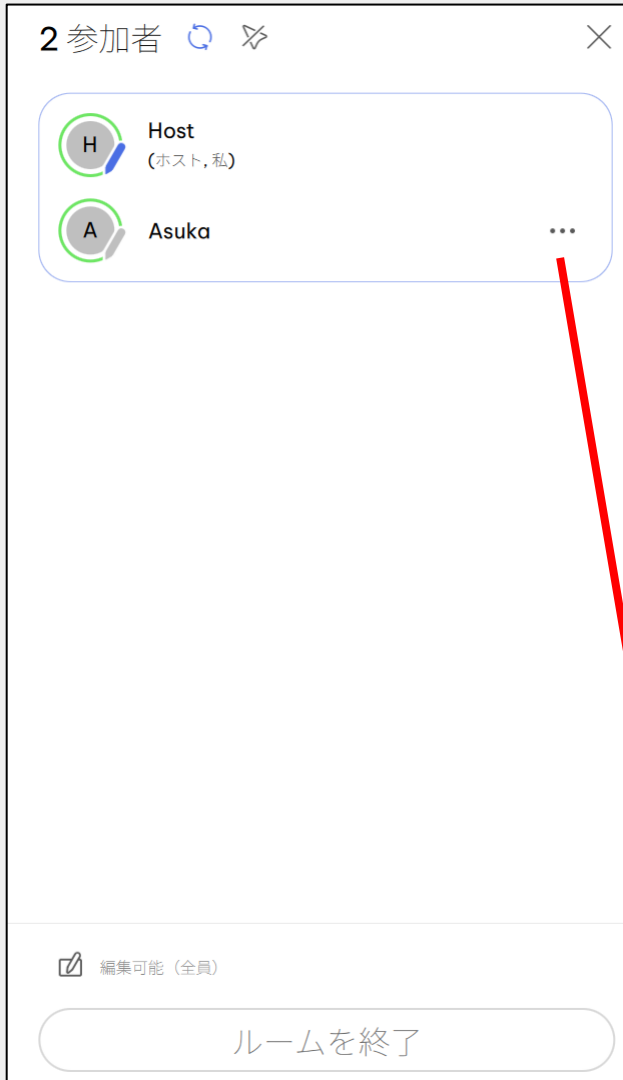

Host (BenQ Board)



Guest (Participant)

Selecting the guest's pen icon makes the post editable and allows the guest to post. (Granting posting permissions)



If you select "Editable (Everyone)," all participating users will be able to post.

挙手を無効にする
退出

Disable notifications to the host

Log out the selected user

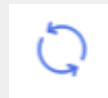

Update the whiteboard

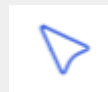

Enable the user cursor

Exiting the cloud whiteboard.

Cloud Whiteboard Function

Raise Hand Feature: Participants can use the Raise Hand feature to notify the host.

Guest

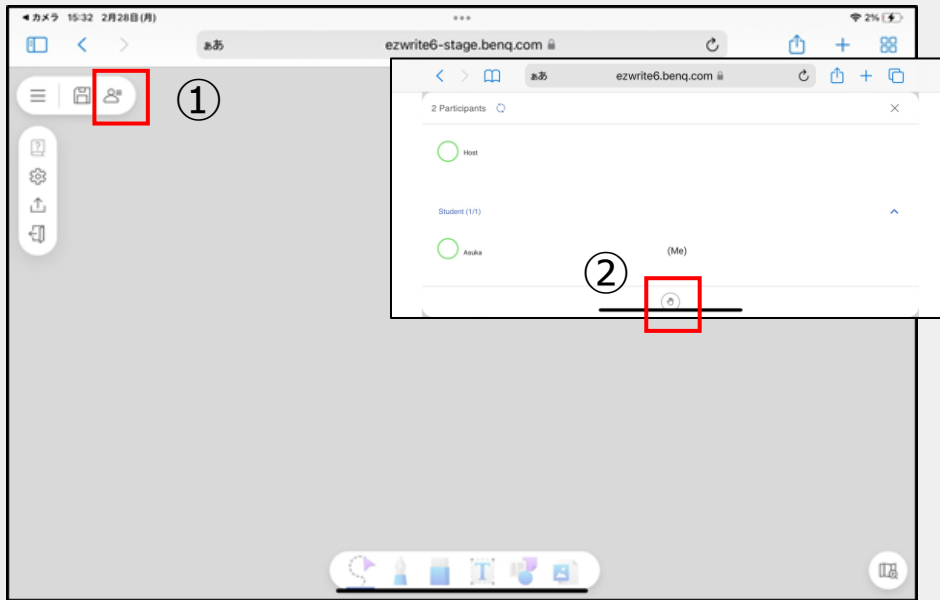

Host
(No notification)

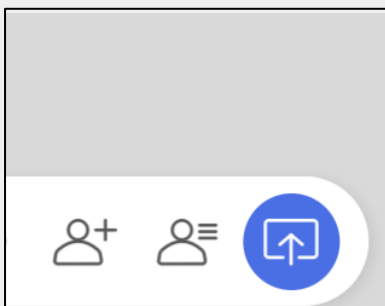

Host
(Notification)

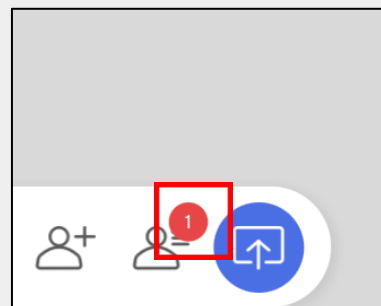

< How to use ④ >

Open Data Files

Open Data Files(AMS File)

Use this to view data saved on the BenQ Board itself or on a USB flash drive.

1. Tap AMS File from the home screen.

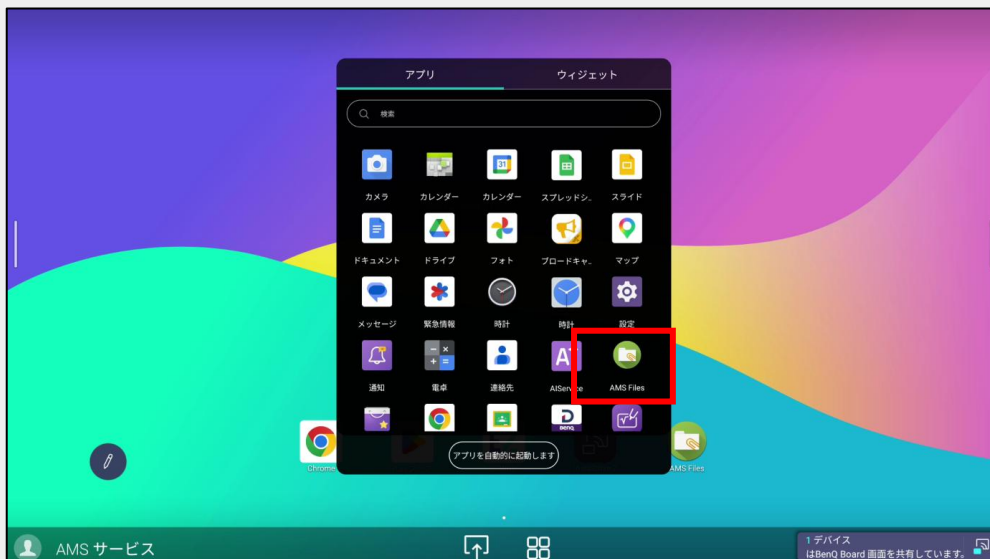

2. Select a drive from the tabs on the left, and select an individual file. The file options also appear on the tabs on the right.

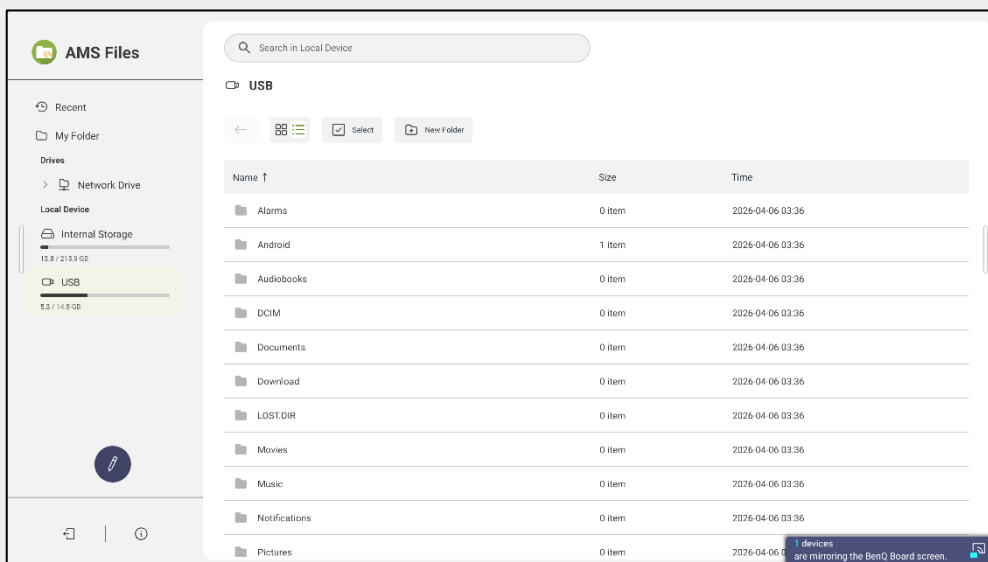

Safely removing external storage

Here are the steps for removing a connected USB flash drive or similar device.

1. In the Settings app, select “Storage”, then select the connected USB flash drive under Devices.

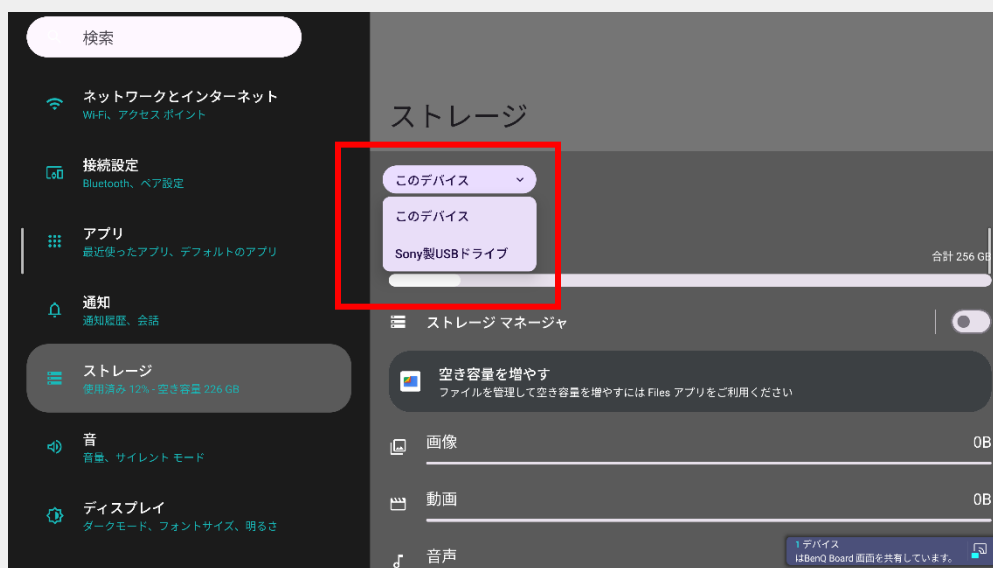

2. Click the  icon in the upper-left corner, select “Eject,” and remove the USB flash drive.

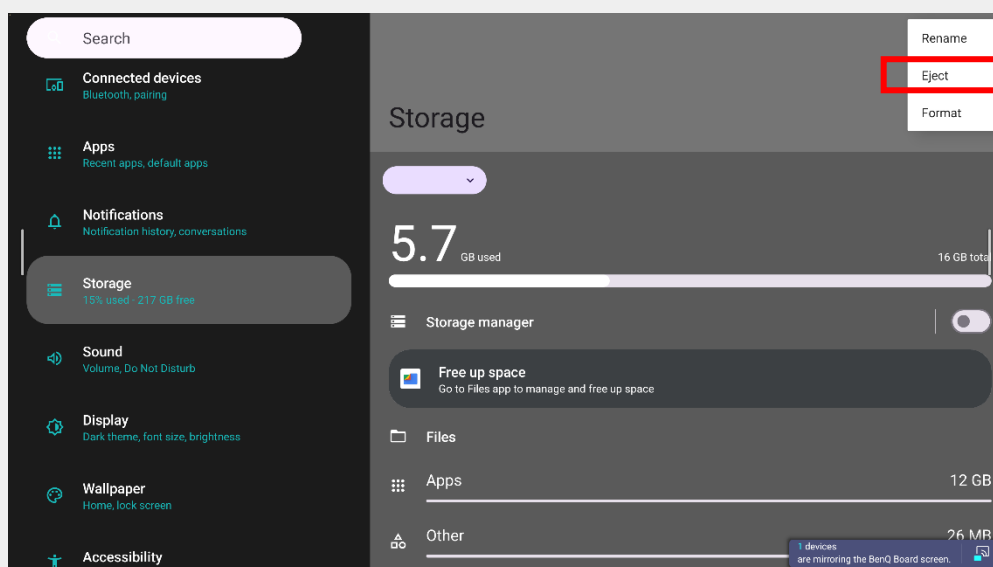

< How to use ⑤ >

How to use Google Play

How to use Google Play

You can download any app from the Play Store and use it on your BenQ Board

*Google account is required to download the application

- Launch the Play Store from the list of applications.

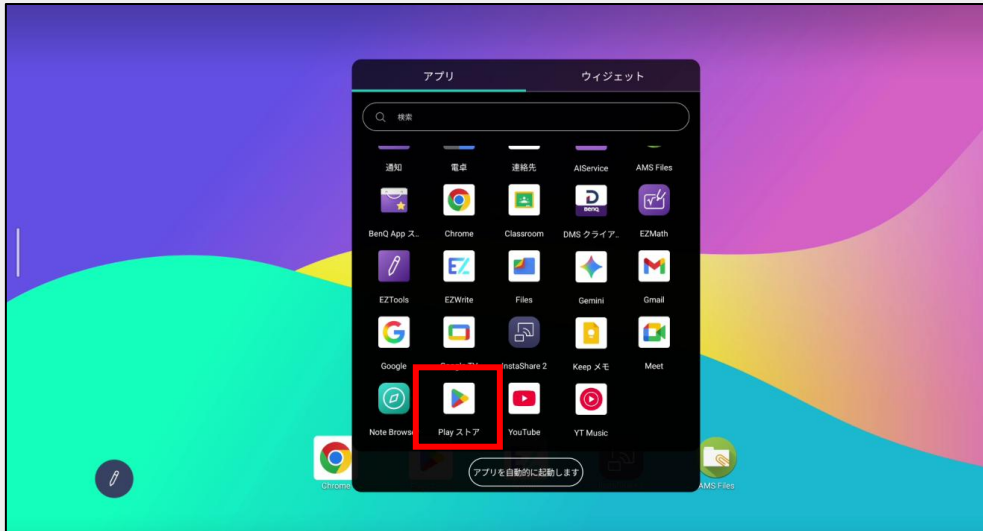

- Search for and install any application you wish. When installation is complete, the app icon will appear on the home screen.

*We are not responsible for any malfunctions caused by applications or services other than those provided by BenQ. Please understand this in advance. Please check the terms and conditions of each provider before using this service.

< How to use ⑥ >

Switching Audio input

Switching Audio input

You can switch between input sources such as the remote control, built-in microphone, and external microphone in the BenQ Board settings.

1. Select the Settings button on the remote control or front panel.



2. From "Advanced Settings", "select Accessories".

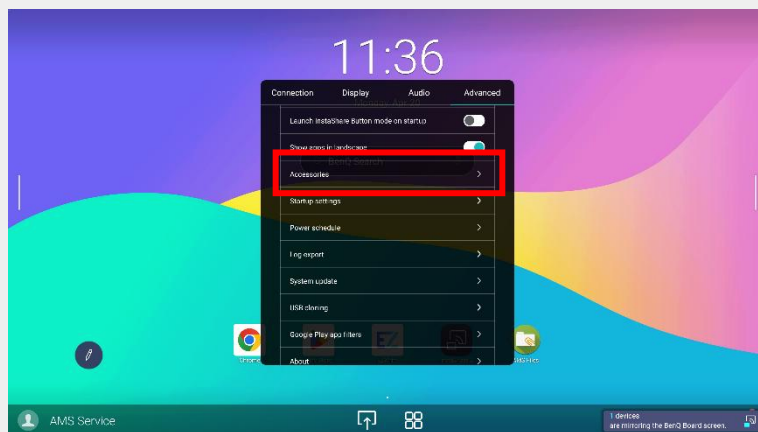

3. Please select your preferred microphone from the microphone settings.

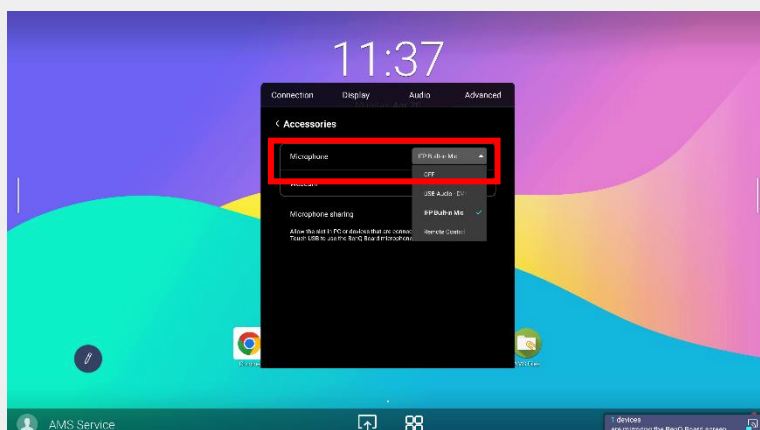

Troubleshooting

BenQ Board does not turn on.

- Check if the power cable is plugged into both the BenQ Board and the power outlet.
- Check if the power switch is on.

PC screen does not show up.

- If the input is with cable, re-plug the cable.
- For InstaShare2, please make sure that the PC and the BenQ Board are connected to the same network. Also, restart both the BenQ Board and the PC.

The BenQ Board and app are frozen.

- Reboot the BenQ Board.

Touch doesn't work.

- Please use a USB mouse or the BenQ Board remote control to check if the touch function is enabled.
- Go to Settings → Devices → Advanced option → Touch lock

If you have any further questions, please contact us

[Contact us]

BenQ Japan Technical Support Center

TEL: 0570-015-533

Email: support@benq.jp

Hours: Monday – Friday, 9:30 - 17:00

(Except Saturdays, Sundays, national holidays and our designated days)