



# Digital Signage/IFP Installation Handbook



## Copyright

Copyright © 2021 by BenQ Corporation. All rights reserved. No part of this publication may be reproduced, transmitted, transcribed, stored in a retrieval system or translated into any language or computer language, in any form or by any means, electronic, mechanical, magnetic, optical, chemical, manual or otherwise, without the prior written permission of BenQ Corporation.

## Disclaimer

BenQ Corporation makes no representations or warranties, either expressed or implied, with respect to the contents hereof and specifically disclaims any warranties, merchantability or fitness for any particular purpose. Further, BenQ Corporation reserves the right to revise this publication and to make changes from time to time in the contents hereof without obligation of BenQ Corporation to notify any person of such revision or changes.

# Table of Contents

Copyright .....	2
Disclaimer .....	2
Display installation guide .....	5
Precautions .....	5
Notes on moving the display .....	5
Notes on installing the display.....	7
Notes on using the remote control.....	8
Cable extension guide .....	10
Video wall installation guide .....	21
Precautions .....	21
Notes on moving the display .....	21
Installing .....	21
Installing edge finishing kit: PL460/PH460/PH550/PL550 .....	25
Making a daisy chain .....	27
Different types of daisy chain .....	29
Operating Instructions of Edge Alignment Kit/Pin: PL490/PL552/PL553/PH5501/PH5502 ....	40
Tiling: PL490/PL552/PL553/PH5501/PH5502 .....	44
Operating Instructions of Edge Alignment Kit/Pin: PL4901/PL5501/PL5502.....	45
Tiling: PL4901/PL5501/PL5502 .....	46
Special signage installation guide .....	48
D series Full HD 55-inch dual-side display .....	48
Mounting installation .....	51
Ceiling Mount.....	51
Notice .....	54
U-Mount .....	56
H-mount .....	60
Digital Signage Bar-Type Series .....	61
Installation notice .....	61
Adjusting the OSD setting: For BH280/BH281/BH380.....	61
BH series HDMI connetion (EXCEPT BH280/BH281/BH380) .....	62
Digital Signage Rotation/Portrait Guide .....	64
Troubleshooting .....	65
Connections.....	65
Picture/video .....	68
Audio .....	71
Remote control.....	71
Touch function (selected models only) .....	72
OSD menu/control panel/power button .....	75
LED indicators.....	77

Power .....	77
System: PL460/PH460/PL550/PH550 .....	79
Troubleshooting: PL490/PL552/PL553/PH5501/PH5502 .....	80
Wall mounting/video wall .....	82
<b>Preventing afterimage burn-in .....</b>	<b>83</b>
<b>Appendix 1: Installation Checklists .....</b>	<b>84</b>
Before installation.....	84
After installation .....	85
Warranty information .....	86
<b>Appendix 2: Basic Troubleshooting Checklists for IFP &amp; IL series .....</b>	<b>87</b>
Part I: customer feedback form (customer information and description of problem) .....	87
Part II: problem resolving attempt & troubleshooting.....	89
Pictures for reference.....	94
<b>Appendix 3: Basic Troubleshooting Checklists for Video Wall .....</b>	<b>90</b>
Part I: customer feedback form (customer information and description of problem) .....	90
Part II: problem resolving attempt & troubleshooting .....	92
<b>Appendix 4: Basic Troubleshooting Checklists for X-Sign .....</b>	<b>96</b>
Part I: customer feedback form (customer information and description of problem) .....	96
Part II: problem resolving attempt & troubleshooting .....	98

# Display installation guide

To ensure safety, please read this manual carefully before installation and follow the instructions herein. Store this installation guide in a secure place for future reference.

At the end of this Installation Handbook are installation checklists that help you to ensure the necessary steps have been completed. Make sure to have the checklists by hand before performing a new installation.

## Precautions

- The display must be installed on a flat and level surface which is strong enough to bear its weight.
- If the display is mounted with a mounting bracket, make sure the bracket is tightened and secured on the wall and is strong enough to bear the weight of the display.
- The Liquid Crystal Display (LCD) panel of the display has a very thin protective layer of glass which is liable to marking or scratching, and cracking if struck or pressured. Please protect the display with cushions during installation.
- Move a display by holding the handles on the back of the display. Do not touch the LCD panel directly to avoid possible scratches. Do not move a display by holding its frames.
- To maintain proper ventilation and heat dissipation, keep at least 60 mm of clear space from the mounted displays to the wall.

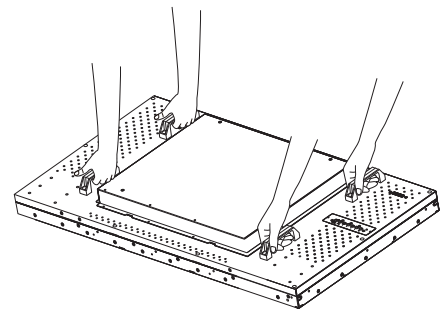

## Notes on moving the display

The display has limited mechanical strength. To prevent the display from performance failure caused by line defects, front bezel bending, glass scratch/broken, light leakage, etc, it must be handled with care. Keep the original shipping box and packaging in storage for use in the future when you may need to transport the product.

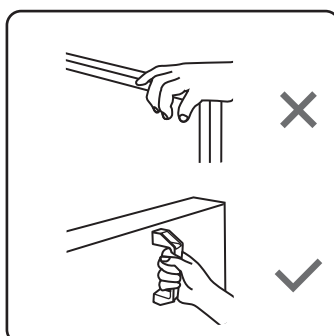

When you want to move the display, make sure the four (4) handles are held.

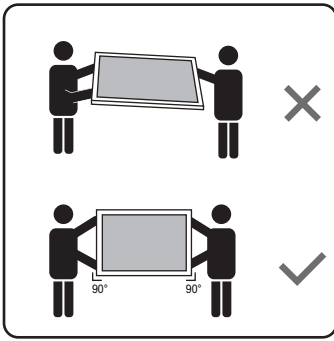

Always move the display by at least two (2) adults with both hands.

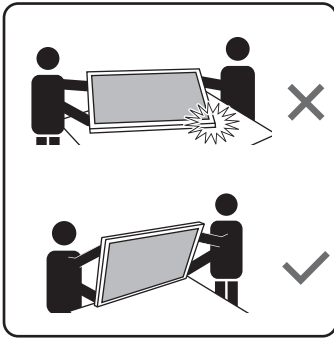

Lay down the display gently and horizontally.

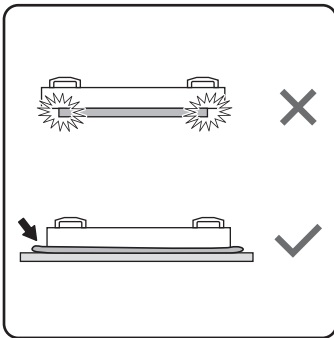

When you want to place the display face down, prepare a flat and horizontal surface that is larger than the display and spread a thick protective sheet on it.

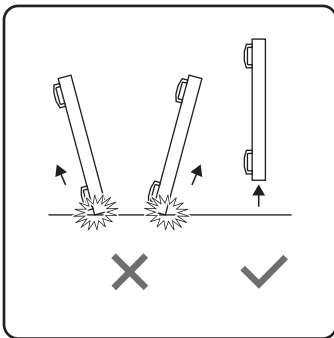

Be careful not to scratch any parts of the display when upturning the display.

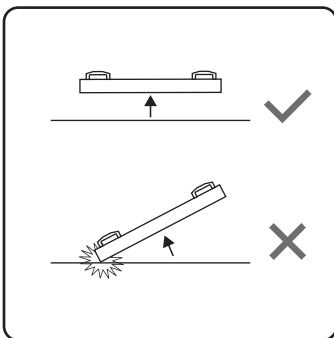

Lift the display up horizontally by holding the four (4) handles. Do not lift the display against its corner.

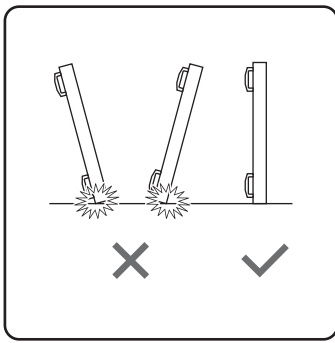

When you want to upturn the display, stand the display vertically to make sure its weight spread evenly on the surface.

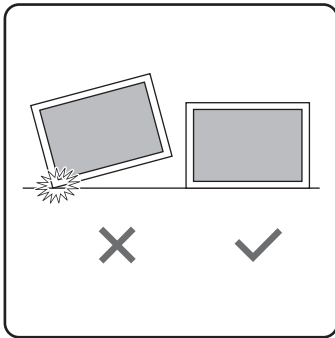

- Check the shock label on the outside of the product carton. The shock indicator on the label will turn red if the display/package is improperly handled (for PL/PH series only).

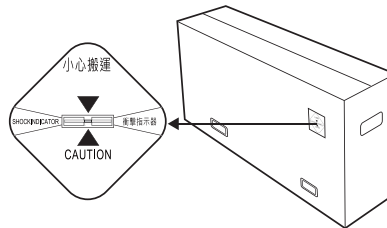

## Notes on installing the display

Installation of this display should only be performed by two (2) qualified technicians. Failure to install this display properly may cause injuries and damages to the personnels and the display itself.

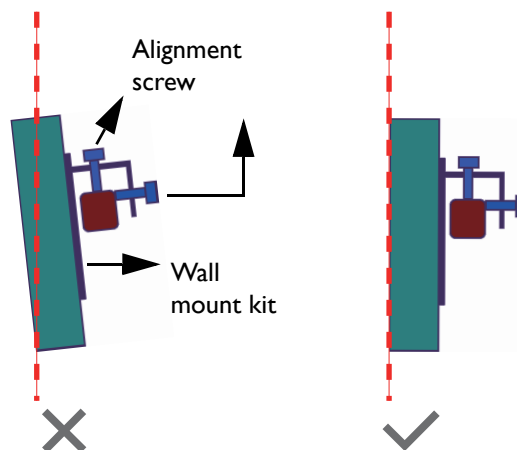

- Be sure to use the alignment screw(s) to set the vertical alignment when installing the display.
- Leave some space in advance when installing the display. Use the alignment screw(s) on the bracket to reduce the gap between the display to avoid collision.
- It is recommended to use the bracket which can be adjusted vertically and horizontally.

- Do not install near any heat source such as radiators, heat registers, stoves, other apparatus (including amplifiers) that produce heat or put the unit exposed to direct spotlight or sunlight.
- It is highly **UNRECOMMENDED** to install products in moving vehicles as there is high risk for breaking the internal hanging-panel films in the long run.
- It is highly **UNRECOMMENDED** to install products in environments with excessive foreign particles floating in the air such as open kitchen. Special countermeasures must be taken to seal the unit completely (leaving some opening for heat dissipation) to minimize the effect of foreign air particles.

## Notes on using the remote control

Point and aim the top front of the remote control directly at the display's remote control sensor window when you press the buttons. Do not let the remote control become wet or place it in humid environments (like bathrooms).

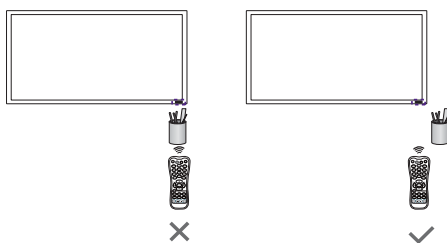

When using the remote control, confirm there is no object between the remote control and the remote sensor of the product.

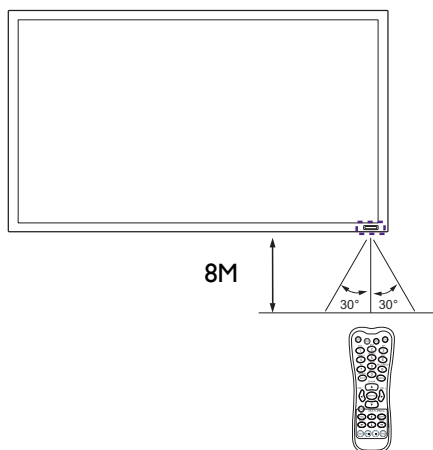

Operate the remote control from a location closer to the display's remote control sensor window. Adjust the distance between the remote control and the display.

Straight-line distance: 8 meters

Transmit angle:  $\pm 30^\circ$



The sensor window's position may vary by models.



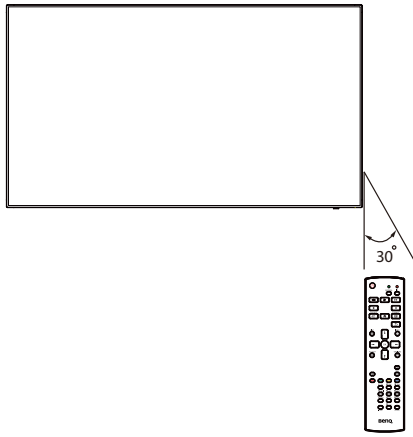

For IL430/IL490/IL550, when two displays place together, the signal of the remote control is easily interfered by the Touch screen signal.

- Do not place the remote control receiver of the display parallel to the front frame of another display or its signal will be interfered by Touch screen's signal. Please keep the distance for at least 20 mm when placing two monitors side by side.
- Use an IR extender cable (3.5 mm cable) to avoid interference between IR remote controller and the Touch Screen when placing multiple displays side-by-side.



The remote control may not function properly when the remote control sensor on the display is under direct sunlight or strong illumination, or when there is an obstacle in the path of signal transmission.

When using the remote control, make sure the display's remote control sensor window is **NOT** exposed to direct sunlight or strong reflected light, e.g. tile flooring.

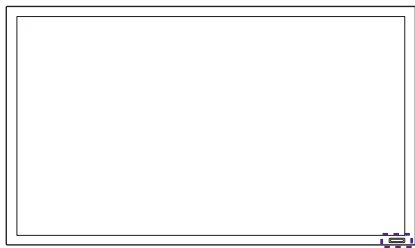

## Cable extension guide

This guide provides additional information about how to extend VGA, HDMI and USB connections as required in the environment where you set up your BenQ digital signage and interactive flat panel displays. Refer to the instructions in this guide and the User Manual of your BenQ display to ensure stable and optimal performance.

Pay attention to the following notes when you connect cables:

- Turn off all devices before making connections.
- Use certified, high-quality cables and signal amplifiers/repeaters.
- Familiarize yourself with the ports and sockets on the display and the devices you want to connect. Be aware that incorrect connections may adversely affect picture quality.
- Do not remove cables from the ports and sockets by pulling the cable itself. Always grasp and pull the connectors at the end of the cable.
- Ensure that all cables are fully inserted and firmly seated for proper pin contact.

## Extending the VGA connection using a VGA amplifier/repeater

If you need to connect the display to a computer or other VGA source devices over a long distance (over 3 meters), a VGA signal amplifier must be used to boost the signal and prevent potential display quality problems like interference and ghosting.

1. Connect the VGA input jack on the display to the VGA output jack on the VGA signal amplifier/repeater using a D-Sub (15-pin) cable.
2. Connect the VGA output jack on the computer to the VGA input jack on the VGA signal amplifier/repeater using a D-Sub (15-pin) cable.
3. Connect the computer's audio output jack to the audio input jack on the display using a suitable audio cable.

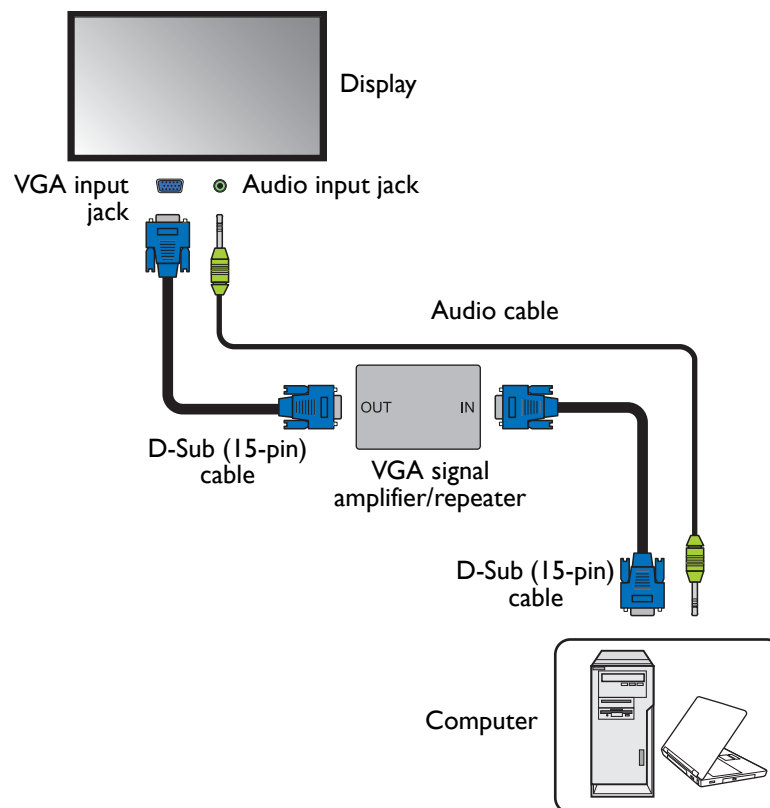

- Refer to the User Manual of your display for the location of VGA and corresponding audio input jacks.
- The audio cable, VGA signal amplifier/repeater and additional VGA cable are not supplied and should be purchased separately.

## Extending the HDMI connection using an HDMI amplifier/repeater

Although there is not an official limit on HDMI cable length (as it mainly depends on the quality of the HDMI cable), in order to prevent potential display quality problems like interference and ghosting, if you need to connect the display to a computer or an A/V device (such as a DVD or Blu-ray player) over 5 meters, deployment of an HDMI signal amplifier is highly recommended.

1. Connect the HDMI input jack on the display to the HDMI output jack on the HDMI signal amplifier/repeater.
2. Connect the HDMI input jack on the HDMI signal amplifier/repeater to the HDMI output jack on the HDMI source device using an HDMI cable.

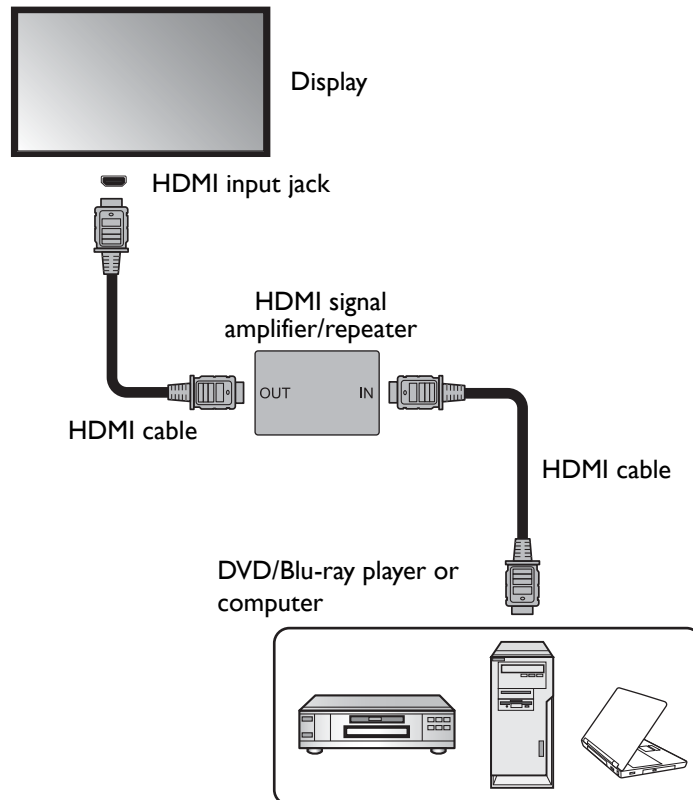

- Refer to the User Manual of your display for the location of HDMI input jacks.
- The HDMI cables and HDMI signal amplifier/repeater are not supplied and should be purchased separately.

## Connecting faceplate

1. Connect the mini-B plug of the supplied USB cable to the USB Mini-B port on the display, and the type-A plug of the cable to the USB port on the faceplate.
2. Connect the computer to the faceplate using a suitable USB cable.

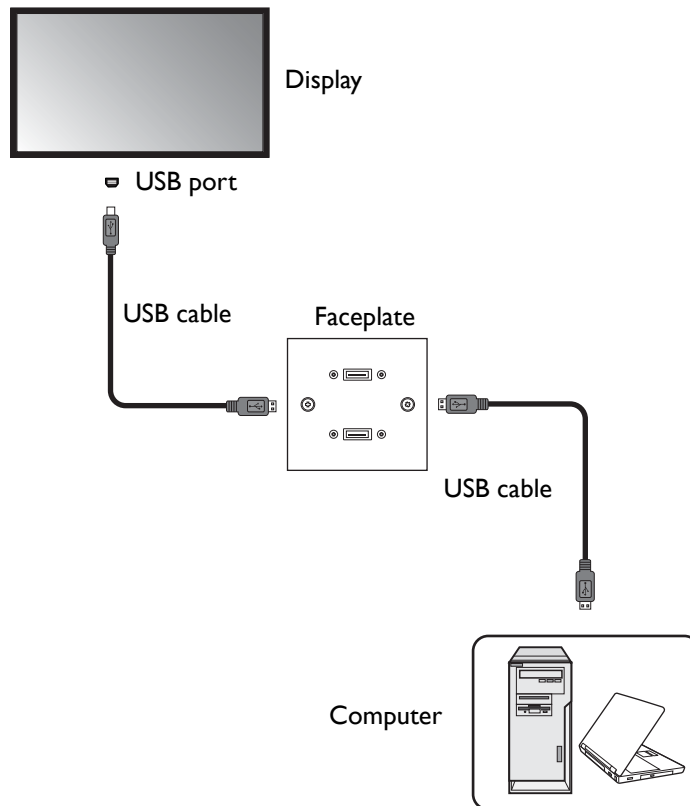

- Refer to the User Manual of your display for the location of USB port.
- Any cable used in prior installations for other displays and projectors in the same location should not be used for a new installation of the display.
- Use only a high-quality faceplate.
- The total cable length between the display, computer and faceplate should not exceed 5 meters. If you need to extend the length of USB connection, refer to ["Extending USB connection" on page 14](#).

## Extending USB connection

### Extending USB connection using an active (powered) USB extension cable

You can use a commercially available active (powered) USB extension cable on the market to extend the length of USB connection. The active USB extension cable helps boost the USB signal as well as provides sufficient bus power for the connected USB device.

1. Connect the mini-B plug of the supplied USB cable to the USB Mini-B port on the display, and the type-A plug of the cable to the USB type-A port on the active USB extension cable.
2. Connect the type-A plug of the active USB extension cable to the USB port of a computer.

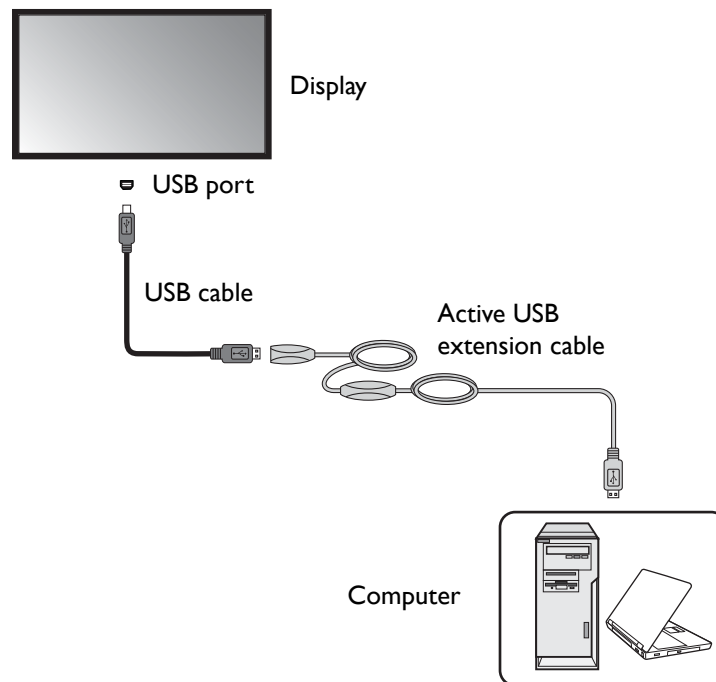

- Refer to the User Manual of your display for the location of USB port.
- For best results, use only a certified active USB extension cable.
- The type of USB port and plug on the active USB extension cable may be different from the description above. Use a USB cable that matches the USB jack on the display and the USB port on the extension cable.
- The length of the USB cable used to connect the display to the USB extension cable should not exceed 5 meters.

### Extending USB connection using an active (powered) USB-CAT converter

You can use a commercially available active (powered) USB-CAT converter (extender) on the market to extend the length of USB connection over a Category 5/5e/6 network cable.

1. Connect the mini-B plug of the supplied USB cable to the USB Mini-B port on the display, and the type-A plug of the cable to the USB type-A port on the active USB-CAT converter.
2. Connect a Category 5/5e/6 network cable to the RJ-45 LAN ports on the converter.

3. Connect the converter to a computer using a suitable USB cable.

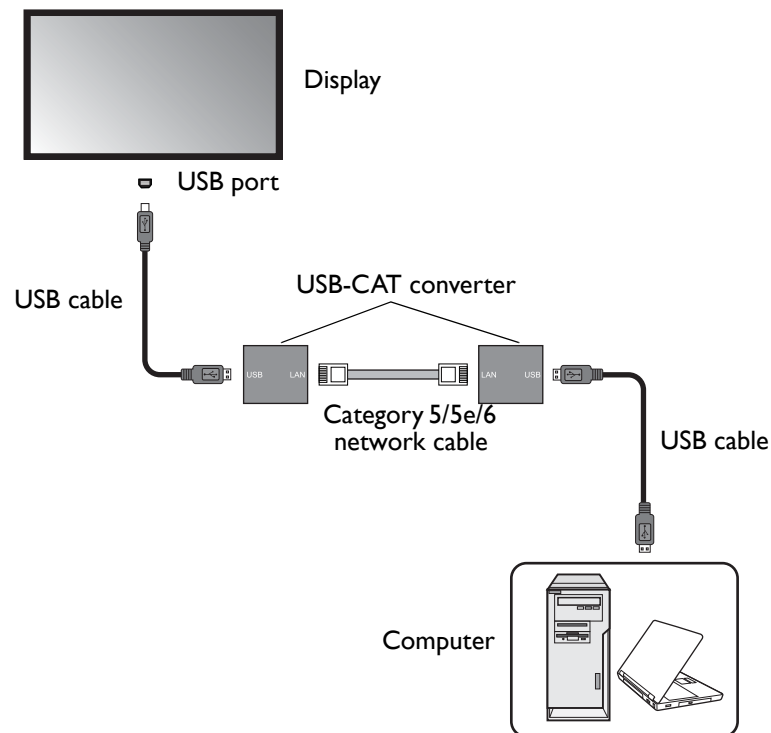

- Refer to the User Manual of your display for the location of USB port.
- Refer to the documentation of the active USB-CAT5 converter for the maximum length of the Category 5/5e/6 network cable.
- The type of USB port and plug on the active USB-CAT converter may be different from the description above. Use a USB cable that matches the USB jack on the display and the USB port on the active USB-CAT converter.
- Keep the Category 5/5e/6 network cable away from power lines and cables to avoid electronic interference.

### Extending USB connection using an active (powered) USB extension cable and a faceplate

Depending on the environment where you install the display, you can use an active (powered) USB extension cable to extend USB connection from a faceplate.

1. Connect the mini-B plug of the supplied USB cable to the USB Mini-B port on the display, and the type-A plug of the cable to the USB type-A port on the active USB extension cable.
2. Connect the type-A plug of the active USB extension cable to the USB port on the faceplate.

3. Connect the computer to the faceplate using a suitable USB cable.

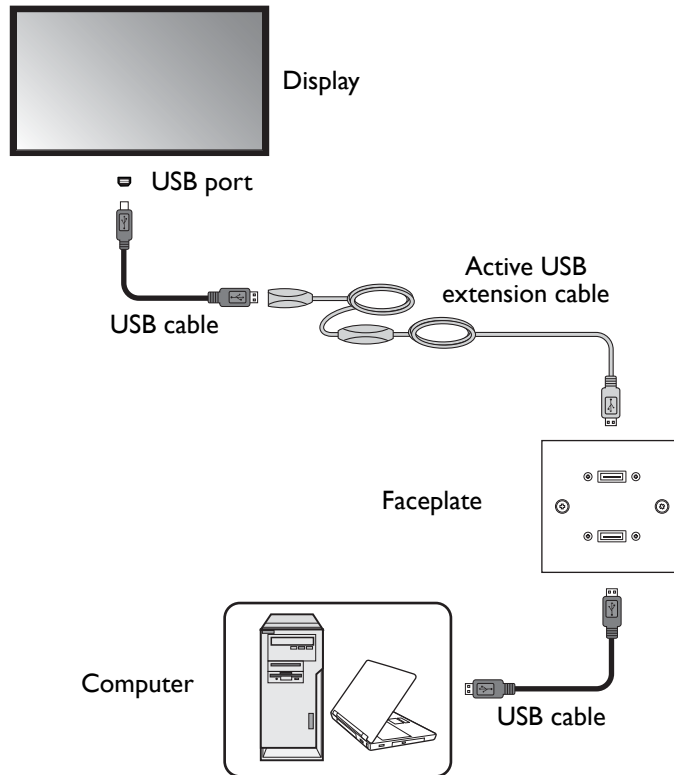

- Refer to the User Manual of your display for the location of USB port.
- For best results, use only a certified active USB extension cable and high-quality faceplate.
- The type of USB port and plug on the active USB extension cable may be different from the description above. Use a USB cable that matches the USB jack on the display and the USB port on the extension cable.
- The total length of the USB cables used to connect the display to the active USB extension cable and computer to the faceplate should not exceed 5 meters.

### Extending USB connection using an active (powered) USB-CAT converter and a faceplate

Depending on the environment where you install the display, you can use an active (powered) USB-CAT converter to extend USB connection from a faceplate.

1. Connect the mini-B plug of the supplied USB cable to the USB Mini-B port on the display, and the type-A plug of the cable to the USB type-A port on the active USB-CAT converter.
2. Connect a Category 5/5e/6 network cable to the RJ-45 LAN port on the converter.
3. Connect the converter to the faceplate using a suitable USB cable.



4. Connect the computer to the faceplate using a suitable USB cable.

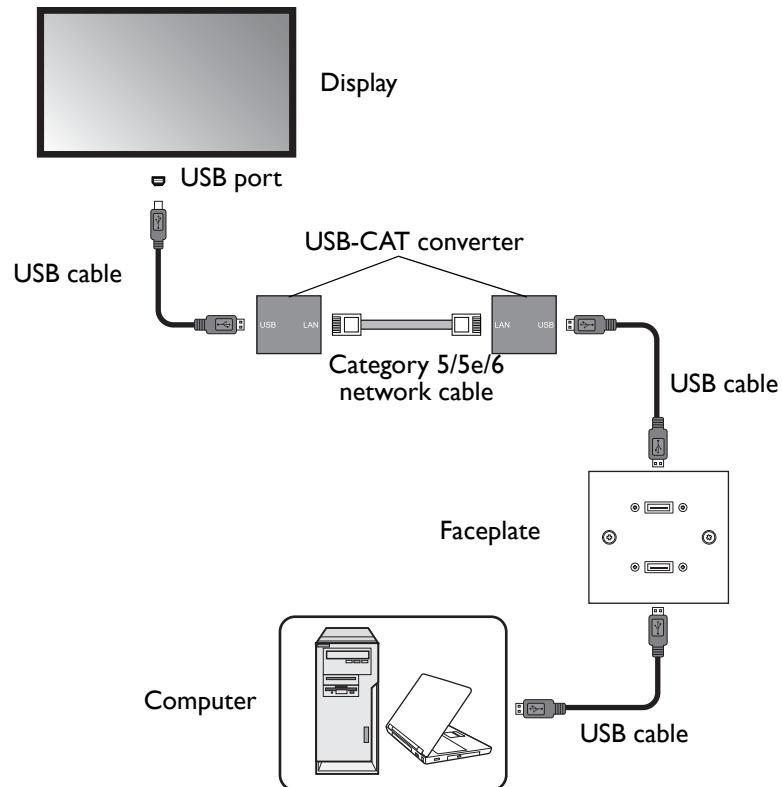

- Refer to the documentation of the active USB-CAT converter for the maximum length of the Category 5/5e/6 network cable.
- The type of USB port and plug on the active USB-CAT converter may be different from the description above. Use a USB cable that matches the USB jack on the display and the USB port on the active USB-CAT converter.
- Keep the Category 5/5e/6 network cable away from power lines and cables to avoid electronic interference.
- The total length of the USB cables used to connect the display to the active USB-CAT converter, converter to the faceplate and computer to the faceplate should not exceed 5 meters.

## Additional information

Your LCD display provides USB 2.0 ports for connecting to various devices including computers, flash drives and wireless LAN adapters. This section provides basic information about the USB 2.0 interface and serves as a reference for the deployment of your USB connections.



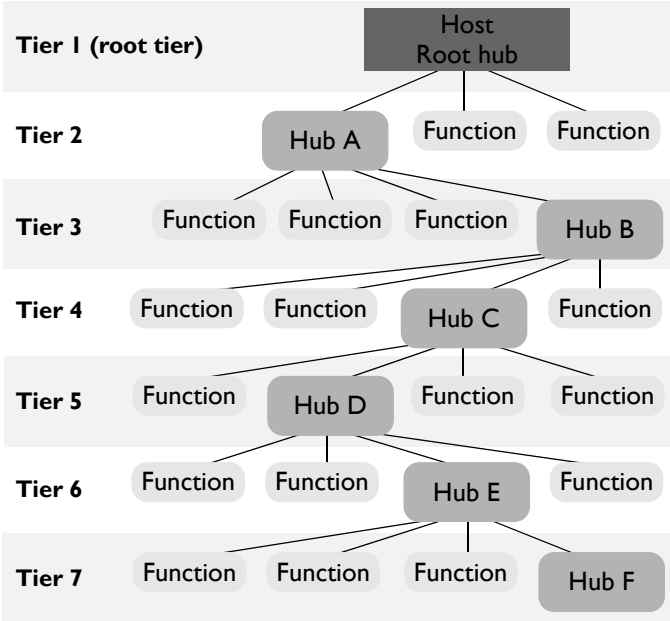









### USB terminology

Term	Description/explanation
<p>Host, Function</p>	<p>A USB network consists of one master and multiple slave devices in a star topology as illustrated below:</p>  <p>The master device (referred to as the “Host”) is on top of all other slave devices (called “Function”). A computer is the most common USB host. Any device that has a USB host controller and related hardware and software installed can also become a USB host. A USB function can be a USB mouse, keyboard or storage device.</p> <p>A maximum of 7 tiers (including the root tier) are allowed in a single USB network. Note that a USB device that performs both as a hub and a function occupies two tiers.</p>

Term	Description/explanation
Upstream	The direction of data transmission from a USB function to a host or hub.
Downstream	The direction of data transmission from a USB host or hub to a function.
Hub	A USB device that provides upstream connection (port) to a host and downstream connections (ports) to multiple functions.
Root hub	A USB host that also performs the functions of a hub.
Speed (low-speed, full-speed and high-speed)	<p>Three different speeds are currently defined in the USB 2.0 specification:</p> <ul style="list-style-type: none"> <li>• Low-speed: data transmission at 1.5Mbps</li> <li>• Full-speed: data transmission at 12Mbps</li> <li>• High-speed: data transmission at 480Mbps</li> </ul> <p>The actual transmission speed is determined by the device with the lower (or lowest) speed. For example, if a low-speed (1.5Mbps) USB peripheral is connected to a high-speed (480Mbps) USB host, the maximum transmission speed between these devices will be 1.5Mbps, not 480Mbps.</p>
Active (self-powered) device	A USB device that has its own power supply and can operate without the power supplied by the USB host.
Passive (bus-powered) device	A USB device that does not have its own power supply and solely relies on the power supplied by the USB host.

## USB connectors and receptacles

USB connectors and receptacles are grouped into two types: Type-A and Type-B.

Type-A		
	Connector	Receptacle
Standard		
Mini		
Micro		
Type-B		
	Connector	Receptacle
Standard		
Mini		
Micro		

- Type-A receptacles are used as outputs from host systems and hubs.
- Type-A plugs are always oriented towards the host system and mate with Type-A receptacles.
- Type-B receptacles are used as inputs to hubs or devices.
- Type-B plugs are always oriented towards a USB hub or device and mate with Type-B receptacles.

## USB cable length

For each passive connection between two USB devices, the maximum length for USB 3.0 is 3 meters, and the maximum length for USB 2.0 is 5 meters. To extend USB connection beyond this length limit, an active extension cable has to be used to ensure stable signal transmission and reliable power supply.

## Prohibited cable assemblies

Some cable assemblies are prohibited in the USB specifications and are not recommended as they may not work in all instances. For example, passive extension cable assembly: a cable that has a Type-A plug on one end and a Type-A receptacle on the other, or a Type-B plug on one end and a Type-B receptacle on the other. This allows multiple cable segments to be connected together, possibly exceeding the maximum permissible cable length.

# Video wall installation guide

To ensure safety, please read this manual carefully before installation and follow the instructions herein. Store this installation guide in a secure place for future reference.

At the end of this Installation Handbook are installation checklists that help you to ensure the necessary steps have been completed. Make sure to have the checklists by hand before performing a new installation.

## Precautions

- The video wall must be installed on a flat and level surface which is strong enough to bear its weight.
- If the video wall is mounted with mounting brackets, make sure the brackets are tightened and secured on the wall and are strong enough to bear the weight of the video wall.
- The Liquid Crystal Display (LCD) panel of the display has a very thin protective layer of glass which is liable to marking or scratching, and cracking if struck or pressured. Please protect the display with cushions during video wall installation.
- Move a display by holding the handles on the back of the display. Do not touch the LCD panel directly to avoid possible scratches.
- To maintain proper ventilation and heat dissipation, keep at least 60 mm of clear space from the mounted displays to the wall.
- Ensure enough gap between displays to protect your LCD screens from the damage through the direct transfer of weight. See [Checking the safe distance between displays on page 23](#) for details.

## Notes on moving the display

The display has limited mechanical strength. To prevent the display from performance failure caused by line defects, front bezel bending, glass scratch/broken, light leakage, etc, it must be handled with care. Refer to [Notes on moving the display on page 5](#).

## Installing

You can cascade the displays in landscape or portrait mode as desired. Mind the space between displays during installation.

## Cascading displays in landscape or portrait mode

1. Install the mounting bracket to the wall following the instruction manual of the wall mounting bracket. Make sure the mounting bracket is vertically and horizontally placed.
2. Attach the provided gap inspection pads to the display edges as instructed in Step 1~3 in [Checking the safe distance between displays on page 23](#).
3. Mount and fasten the display on the mounting bracket or stand by tightening the screws through the respective holes with a Phillips (cross) screwdriver. Do not place one display directly on another as the stacked LCD screens may be damaged by the weight.

- Start your video wall from the bottom left or bottom right. Finish one row and then move up to finish the next row. Once a display has been installed, check the horizontal and vertical level immediately using a professional measuring tool.

Landscape mode

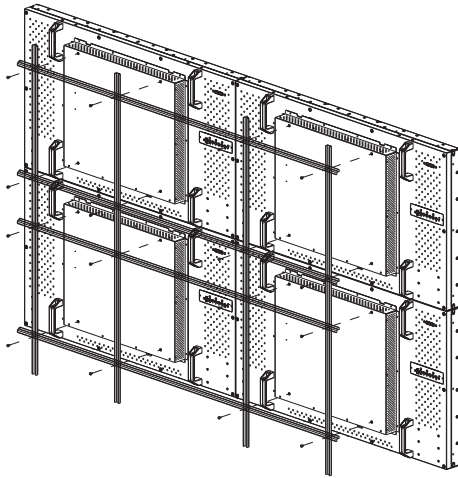

Portrait mode

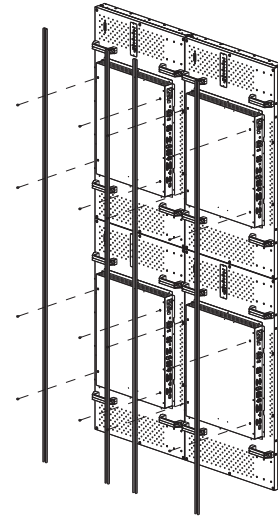

Rotate each display 90 degrees clockwise to install the video wall in portrait mode.

- Place your displays as close to each other as possible but an appropriate space of at least 0.5 mm should be kept. Check the gap between displays as instructed in Step 4~5 in [Checking the safe distance between displays](#) on page 23.
- To maintain proper ventilation and heat dissipation, keep at least 60mm of clear space from the mounted displays to the wall.

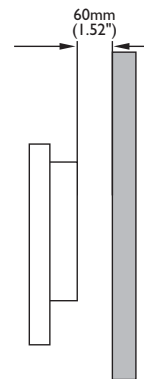

Various mounting brackets may be available to you, but only some of them are suitable for a video wall.

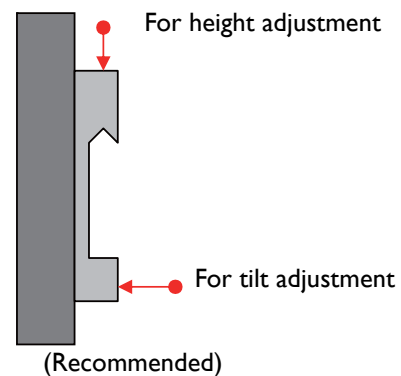
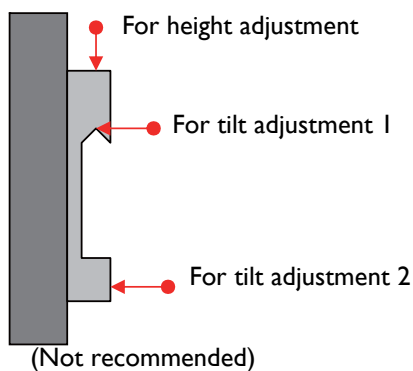

## Checking the safe distance between displays

During video wall installation, you might want to place the displays as close to each other as possible. Note the LCD screens may be damaged through the direct transfer of weight if an appropriate distance is not kept between displays. The recommended gap between displays may vary depending on your purchased models as listed below.

Model name	Recommended gap between displays
P Series	$\geq 0.5$ mm

Actual bezel-to-bezel dimensions may exceed the listed minimum values (5.4mm for PH460/PL460, 3.5mm for PL490/PL550/PL552/PH5501/PL4901/PL5501, 1.8 mm for PL553/PH5502, 0.88mm for PL5502) due to different tiling methods.

You are provided with gap inspection pads to ensure appropriate space between the cascaded displays during video wall installation.

1. Get one of the provided gap inspection pads and fold it as illustrated.
2. Remove the peeling sheet from the gap inspection pad.



3. Stick the pad to the edge where another display will be stacked as illustrated. Each edge should have 3 gap inspection pads attached.

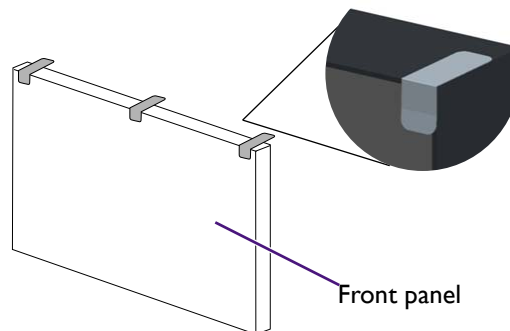

4. After the displays are mounted and fastened, check if the space between each display is just enough for removing the gap inspection pad smoothly. If the pad is trapped, adjust the screws to release more space.

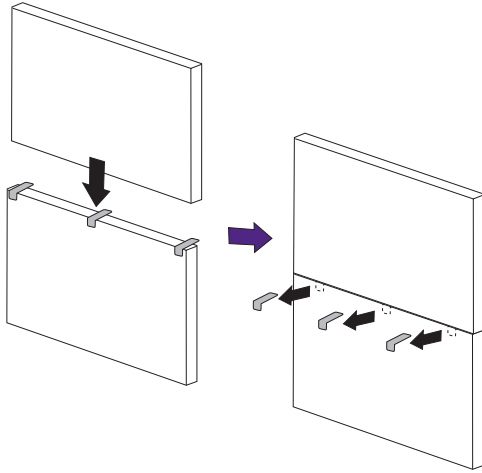

5. Insert the pad again and swipe the pad horizontally and vertically between the gap to ensure it can move smoothly. Ignore the black tapes on the edge if they stop you. Refer to [Recommended gap between displays on page 23](#) for the minimum distance required for each model.

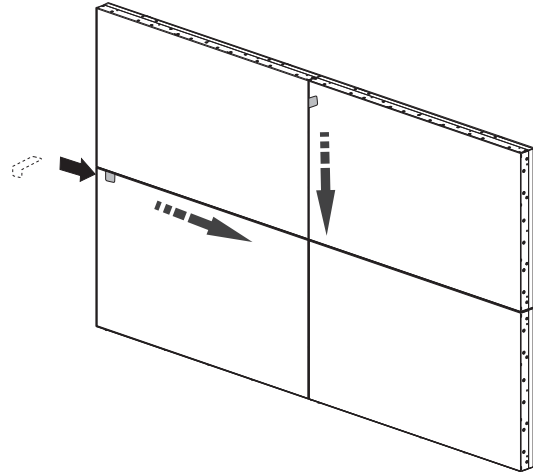



## Installing edge finishing kit: PL460/PH460/PH550/PL550

Whether used as a standalone unit or as a part of a video wall, the edge finishing kit will transform your display into a most stylish and elegant display.

Inside your edge finishing kit you will find the following components:

### Cosmetic Plates

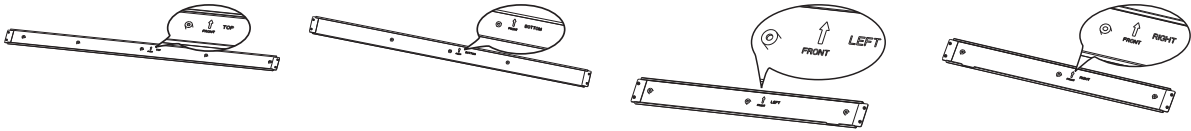

Top (A)

Bottom (B)

Left (C)

Right (D)

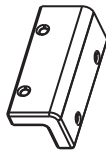
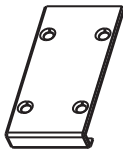

Flat Enclosure (E)

Corner Enclosure (F)

M3 x 5 mm Screw (G)

M4 x 6 mm Screw (H)

## Installation

### For standalone unit

1. Mount the cosmetic plates in their respective places on the edge of your display, and screw in to place using the 6mm M4 screws.
2. On each corner, mount a corner enclosure piece and fasten each one with 4 of the 5mm M3 screws.

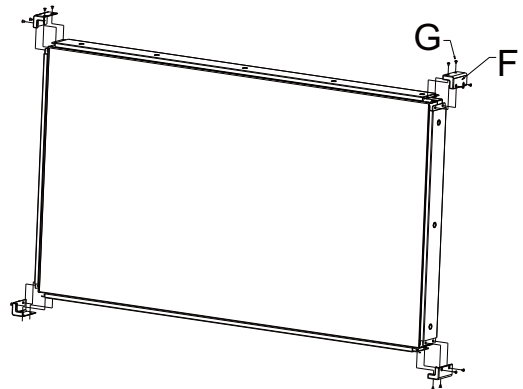
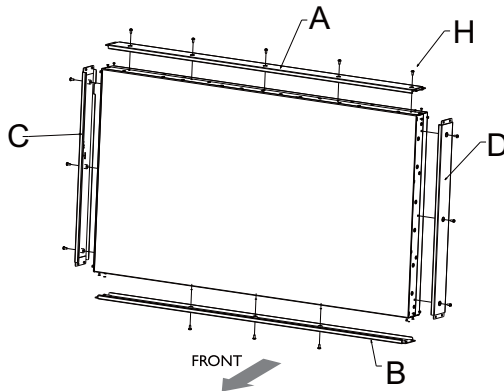

## For a landscape video wall

1. Mount the cosmetic plates in their respective places on the edge of your display, and screw in to place using the 6mm M4 screws.

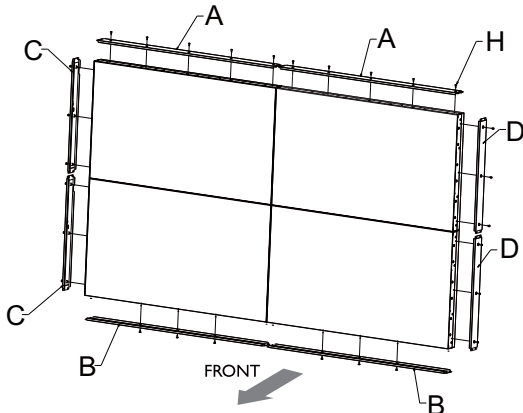

2. On each corner, mount a corner enclosure piece and fasten each one with 4 of the 5mm M3 screws. Where the displays meet, use a flat enclosure piece, and fasten each of these too with 4 of the 5mm M3 screws.

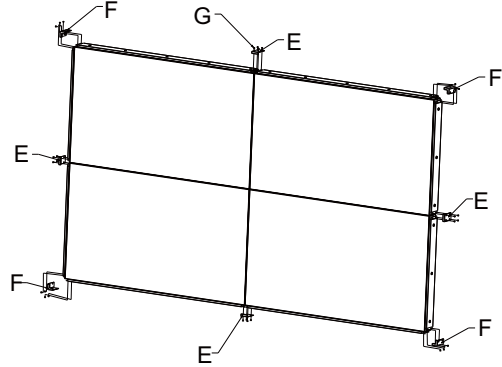

When mounting, make sure that all edge enclosure pieces are fitted to the respective positions (i.e. bottom to bottom, etc.)

## For a portrait video wall

1. Mount the cosmetic plates in their respective places on the edge of your display, and screw in to place using the 6mm M4 screws.

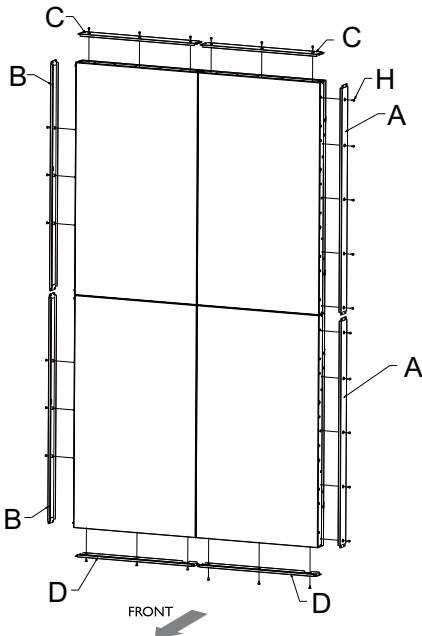

2. On each corner, mount a corner enclosure piece and fasten each one with 4 of the 5mm M3 screws. Where the displays meet, use a flat enclosure piece, and fasten each of these too with 4 of the 5mm M3 screws.



When mounting, make sure that all edge enclosure pieces are fitted to the respective positions (i.e. bottom to bottom, etc). When rotating, the RIGHT side of the displays should be on the bottom.

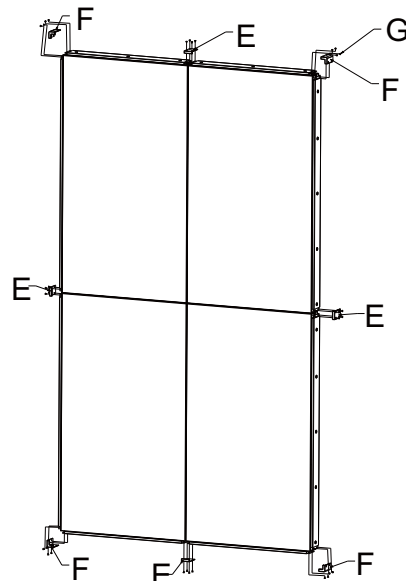

## Making a daisy chain

Once you have installed the video wall, you are ready to connect all displays serially as a daisy chain for playback or centralized management.

Follow the steps below to form a daisy chain, and refer to the mentioned sections for more information.



In this chapter, illustrations of 4 daisy chained displays are for your reference only. You can connect more displays if needed, as long as it is within the limit of each daisy chain to ensure picture quality. See [Number of daisy chained displays on page 30](#) for more information.

1. Install the video wall. Follow the instructions in [Video wall installation guide on page 21](#).

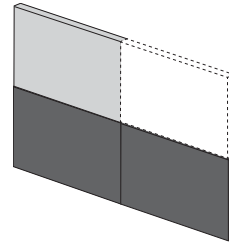

2. Connect the video source (e.g. computer) and loop all displays using the required cables. See [Cable connections on page 28](#) and [Cable extension guide on page 10](#) for more information.

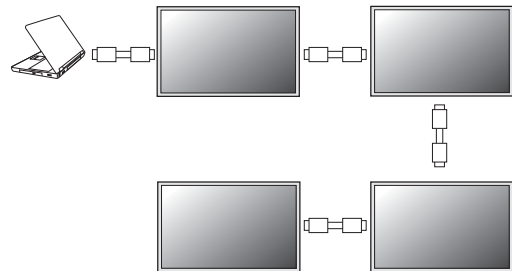

3. Set the horizontal and vertical position of the display wall matrix. This helps your computer identify how many displays are connected and how to display the image. See [Setting the display position on page 31](#) for more information.

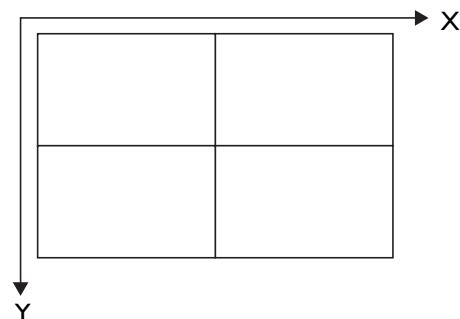

4. Set the ID number of each display for video wall management. See [Setting the ID number of each display: PL460/PH460/PL550/PH550 on page 34](#) for more information.



- Decide the way to manage all the daisy chained displays. See [Managing the daisy chain: PL460/PH460/PL550/PH550](#) on page 35 for more information.

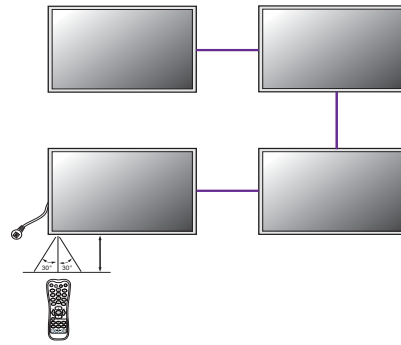

- Change the display settings to optimize video wall performance as suggested. See [Optimizing the video wall performance and management: PL460/PH460/PL550/PH550/PL490/PL552/PL553/PH550 I/PH5502](#) on page 38 for more information.

## Cable connections

- Turn off all devices.
- Connect the first display with the video source (e.g. computer).
- Connect one end of the cable to the appropriate OUT port on the first display.
- Connect the other end of the cable to the appropriate IN port on the second display. Follow Step 2 ~ 3 to connect all displays. Refer to the user manual of the purchased model for the location of all input and output ports.

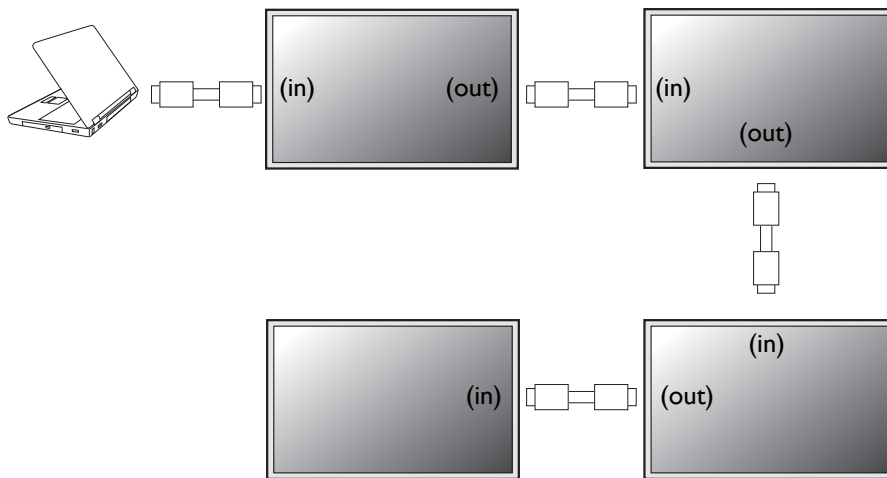

## Different types of daisy chain

Depending on your needs and input source, different cables should be connected properly.

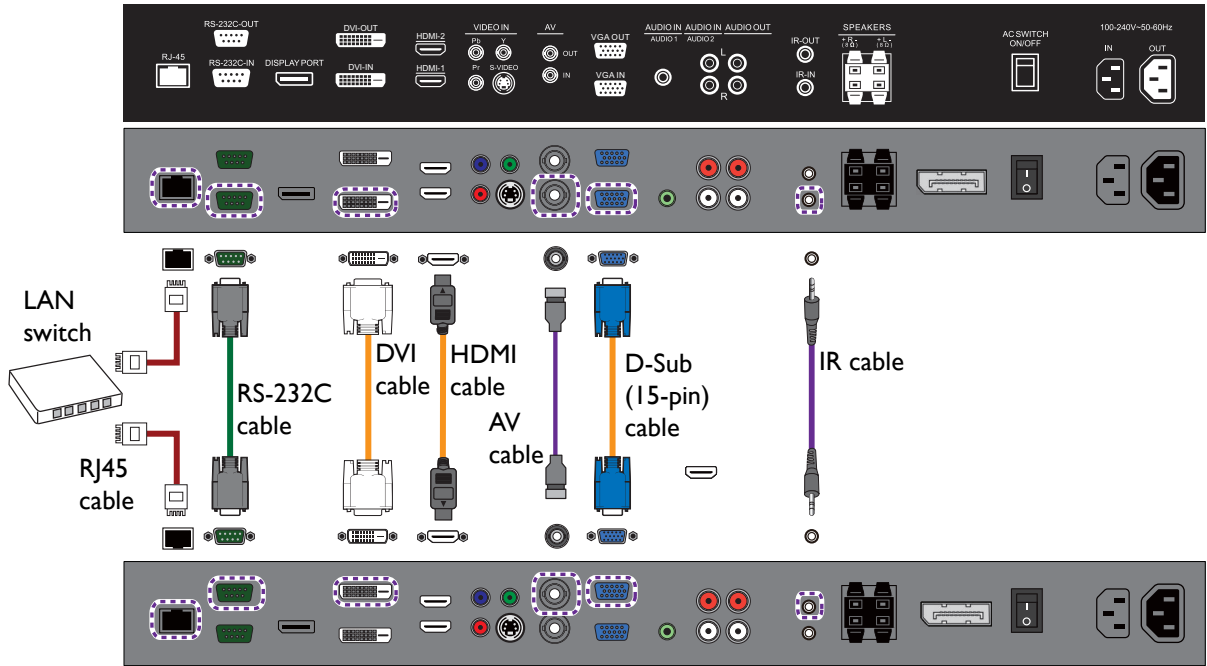

The second display (connected to the IN ports)



The first display (connected to the OUT ports)



- Not all cables and daisy chains are available for all models. Check the specifications of the purchased model for the available connections.
- For cables that are not supplied with your product, you can purchase them separately.

Function	Cables required for each display	Reference
Video signal transmission	<ul style="list-style-type: none"> <li>• D-Sub/Composite cable for analog signals</li> <li>• DVI/HDMI/DP cable for digital signals</li> </ul>  D-Sub, Composite, and DVI support daisy chaining. If the video output is HDMI, you can use an adapter to convert the signal into either DVI or Composite before making the daisy chain.	
Audio signal transmission (selected models only)	Audio cable	
OSD control or advanced control of all displays via remote control (selected models only)	IR cable	<a href="#">Page 35</a>
Control of all displays by RS-232 commands	RS-232C cable.  Use an appropriate RS-232C cable. Refer to the user manual or BenQ service for more information.	<a href="#">Page 36</a>

Function	Cables required for each display	Reference
Control of all displays through Local Area Network (LAN)	RJ45 cable	<a href="#">Page 36</a>

## Number of daisy chained displays

The number of displays you can loop out serially depends on the resolution and type of the input signal. Refer to the following table for the recommended and maximum number of displays for different daisy chains.

Input signal	Recommended number of display	Maximum number of display (without a signal splitter)
DVI-I (Analog)	4	9
DVI-I (Digital signal)	16	25
DP	PL/PH series: 9 SL series: 16	PL/PH series: 12 SL series: 25



If connection of more than the maximum number is required, use appropriate signal splitters to ensure stable signal transmission, and you can loop up to 100 displays for PL460, PH460, PH550 and 225 displays for PL490, PL550, PL552, PL553, SL490, SL550, PH5501, PH5502, PL5502, PL4901, PL5501.



The design of ID setting is different by models.

PL490/PL550/PL552/PL553/SL490/SL550/PH5501/PH5502/PL5502/PL4901/PL5501: 15 x 15

PL460/PH460/PH550: 10 x 10

## Setting the display position

After all the displays are installed properly to a video wall, you need set the position of each display to determine how to display the input image.

Without setting the display position, each display outputs the complete picture independently.

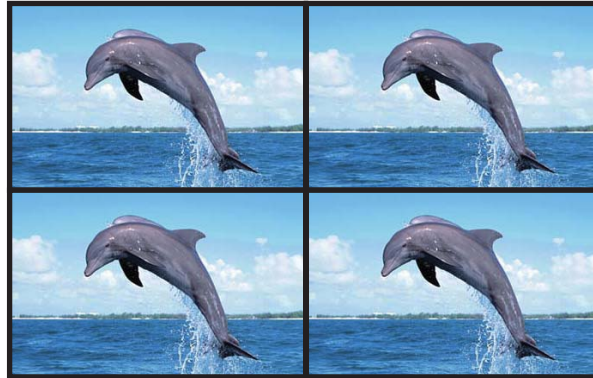

Once the position is set, the video source (e.g. computer) identifies the number of connected displays and transfer part of the picture to each display accordingly. The video wall then outputs one picture as a whole.

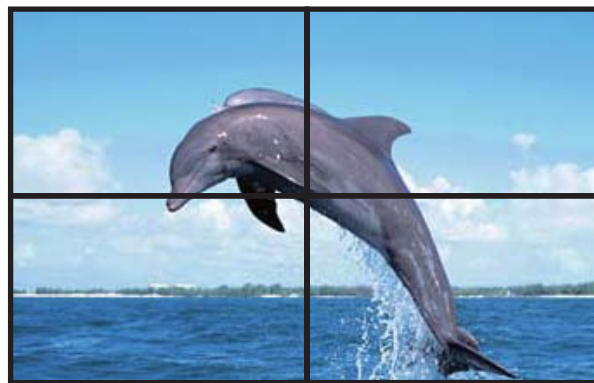

If you prefer to show different pictures on the displays of the video wall, you will need to have independent video source for each display.

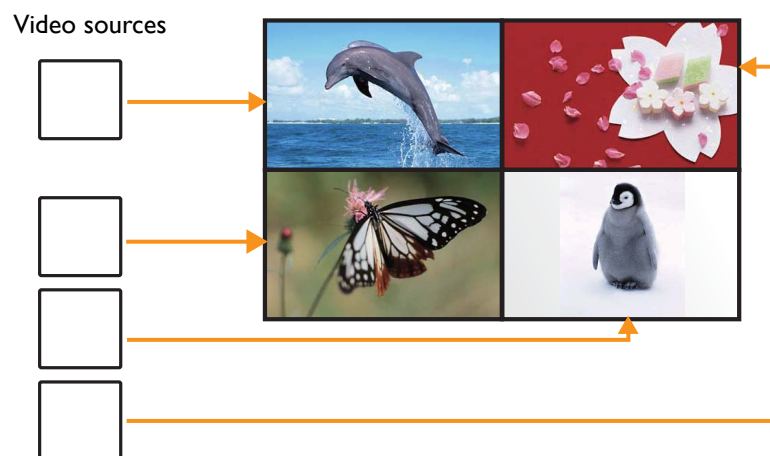

Though the video sources vary, you can still manage all displays via remote control, RS-232 commands, or LAN control in this case.

## Setting the display position in landscape mode: PL460/PH460/PL550/PH550

If a landscape video wall has been installed, follow the procedures to set the display position.

1. Go to **Screen > Display Wall > H. Monitors** and **V. Monitors** on each display to set the total number of displays counted horizontally and vertically.
2. Go to **Screen > Display Wall > H. Position** and **V. Position** on each display to set the position. The position is defined by the X-Y matrix. Starting from the top left of the video wall, the number increases as it goes down or goes to the right.

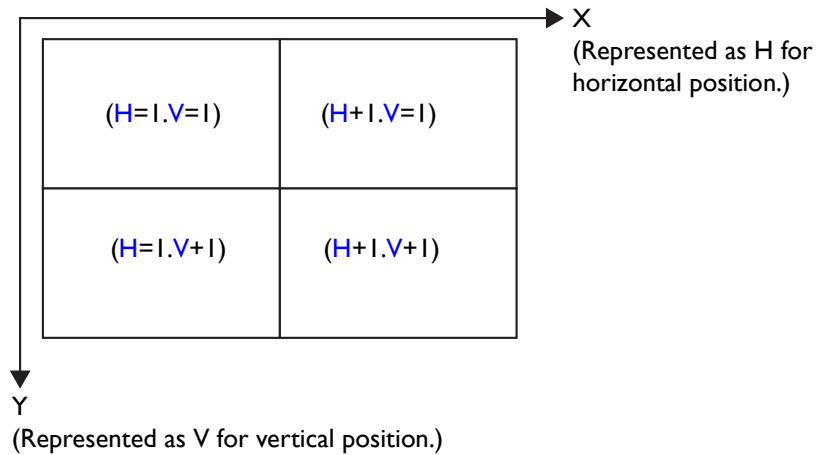

## Different video wall layouts and display position setup

Set the display position carefully according to the video wall layout to ensure correct picture output. Following are some examples for your reference.

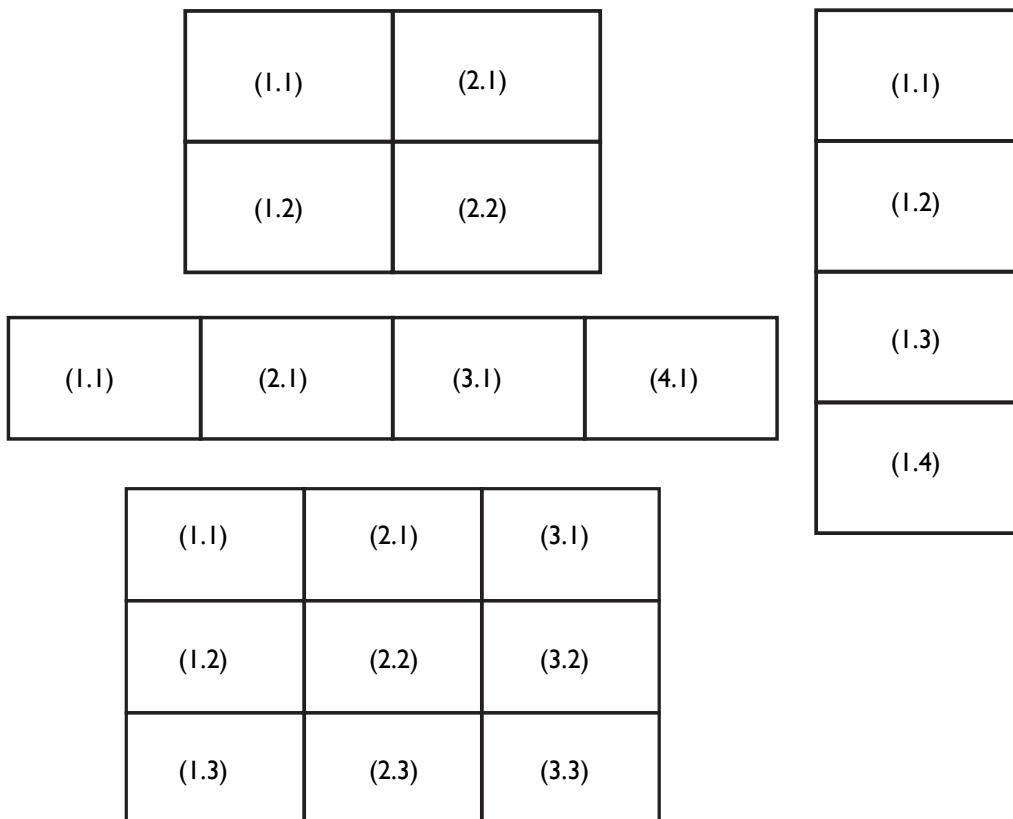



## Setting the display position in portrait mode

If a video wall in portrait mode is desired, follow the procedures and refer to the matrix and examples for setup.

1. Rotate each display 90 degrees clockwise to install the video wall in portrait mode.
2. Rotate the picture 90 degrees counterclockwise from your video source (e.g. computer).
3. Rotate the OSD menu from each display. Go to **Setting > Advanced > OSD Rotation** and set it to **Portrait**. Alternatively, wait until the IR loop is created, then change the setting on one display to apply to all displays. See [Management by remote control \(selected models only\)](#) on page 35 for more information.
4. Go to **Screen > Display Wall > H. Monitors** and **V. Monitors** on each display to set the total number of displays counted vertically and horizontally.
5. Go to **Screen > Display Wall > H. Position** and **V. Position** on each display to set the position. The position is defined by the X-Y matrix. Starting from the top left of the video wall, the number increases as it goes down or goes to the right.

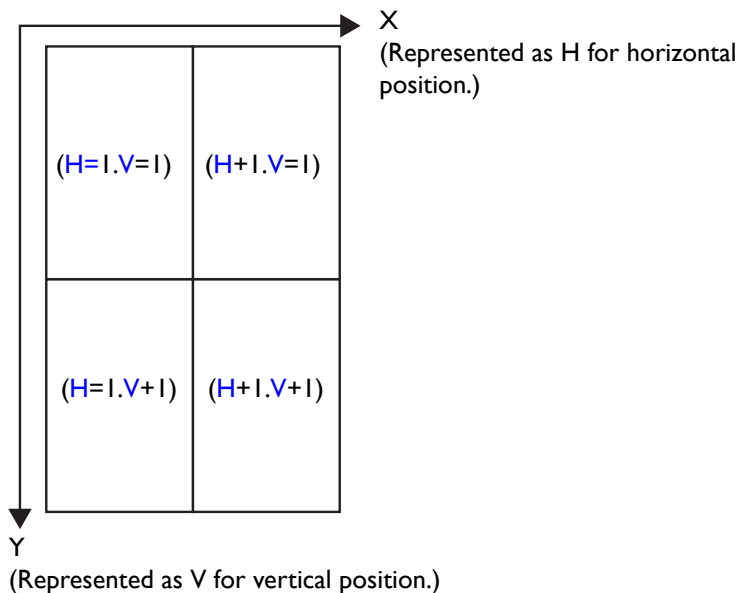

## Different video wall layouts and display position setup

Set the display position carefully according to the video wall layout to ensure correct picture output. Following are some examples for your reference.

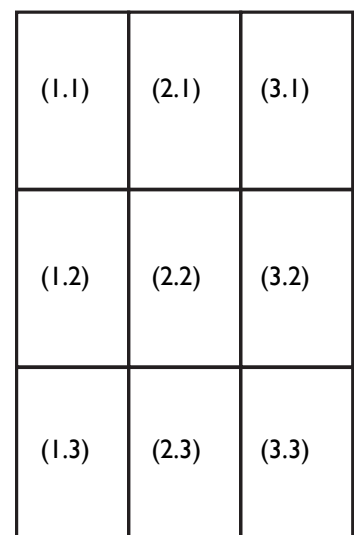
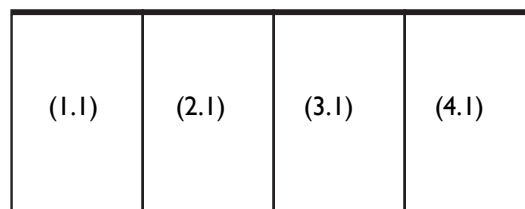
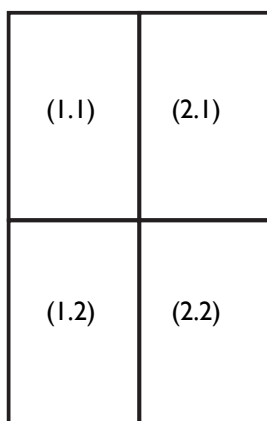

## Setting the ID number of each display: PL460/PH460/PL550/PH550

Once you have installed the video wall, you need to set an ID number for each display to identify one among the multiple displays easily. This is helpful for video wall management, such as power management, OSD control, or color management. It is also helpful if additional adjustment is required for a specific display.

To set the ID number, go to **Setting > Set Monitor ID** on each display for configuration. Pay attention not to set the same ID number for different displays, as the commands for video wall management would not be received correctly.

Set the ID number starting from 1 to 98, depending on the number of displays daisy chained. There is no specific direction while going through all displays setting up the ID numbers.

Following are some examples for your reference.

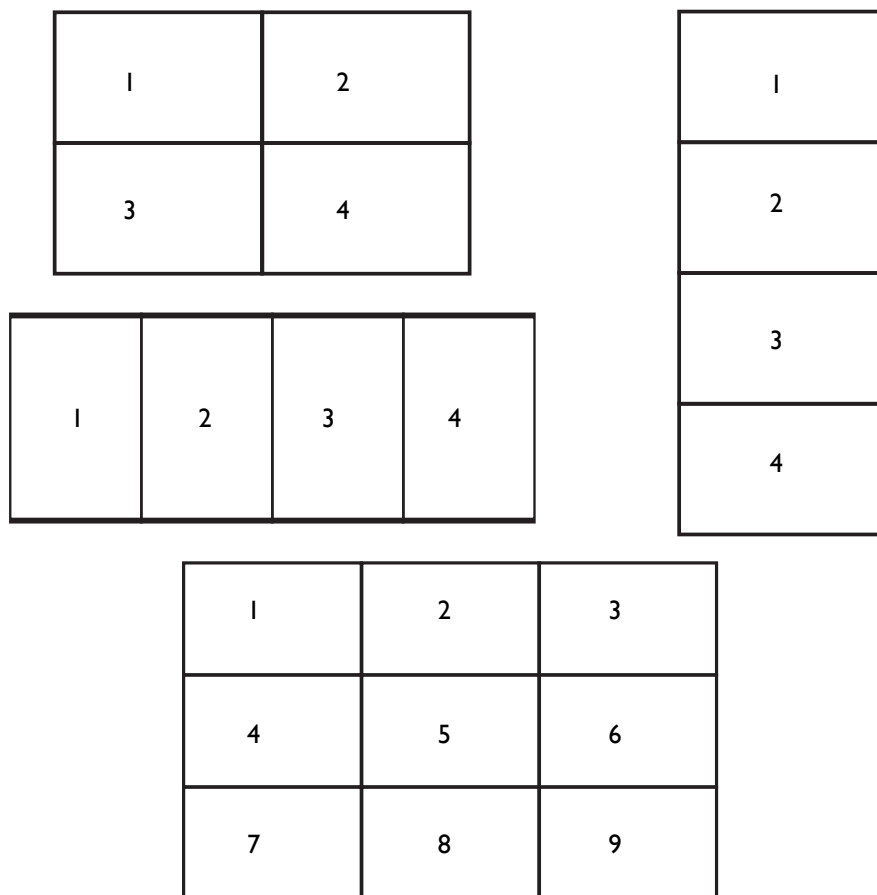

To set the ID number of each display for PL490/PL552/PL553/PH5501/PH5502, adjust the ID number for controlling the display via the RS232C connection. Each display must have a unique ID number when multiple sets of this display are connected. Monitor ID number range is between 1 to 225. The default setting is 1.



All models of MDA only support from 1-98.

## Managing the daisy chain: PL460/PH460/PL550/PH550

Once the displays have been daisy chained and the position and ID numbers have been set, you need to decide a way to control all displays centrally. The centralized management could be done by remote control, RS-232 commands, or LAN control.

### Management by remote control (selected models only)

1. Connect all displays using the IR cables (purchased separately if not supplied).
2. Connect the supplied IR extender to the **IR-IN** at the back of the first display.
3. Aim the supplied remote control at the IR extender just connected within the motion range.
4. Go to **Setting > Advanced > IR Out** on each of the displays to create an IR loop. Now you are ready to control all displays using the remote control. Refer to the user manual of the purchased model for the operation of remote control.
5. Refer to [Notes on using the remote control on page 8](#) for more information.

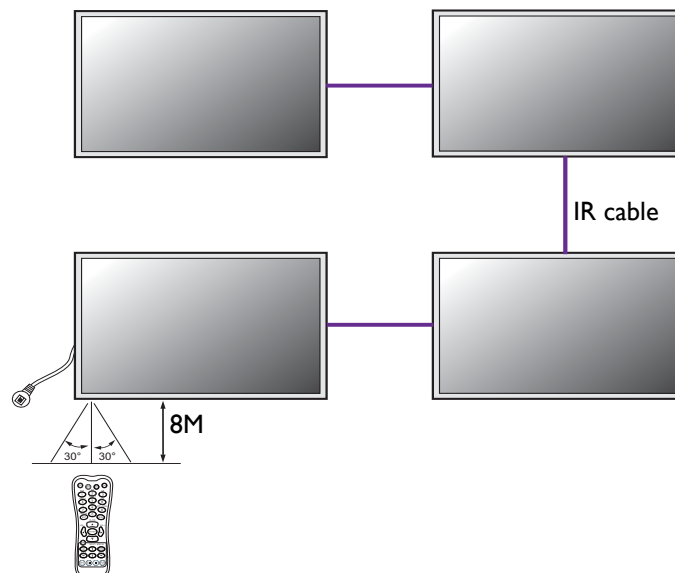

• RS232 daisy chain only supports up to 98.

• For PL490/PL552/PL553/PH5501/PH5502, RS232 daisy chain is only up to 98 and monitor ID number range is between 1 to 225.

## Management by RS-232 commands: PL460/PH460/PL550/PH550

The video wall can be managed by receiving RS-232 commands from a computer.

1. Make sure the ID number has been set for each display. See [Setting the ID number of each display: PL460/PH460/PL550/PH550 on page 34](#) for more information.
2. Connect the computer to a display using a RS-232C serial null modem cable (purchased separately if not supplied).
3. Connect all displays using the RS-232C serial null modem cables (purchased separately if not supplied).
4. Go to **Setting > Control Setting** each display. Select **RS-232C**.
5. Refer to the RS-232 protocol document (downloaded from the BenQ local website) for the commands.

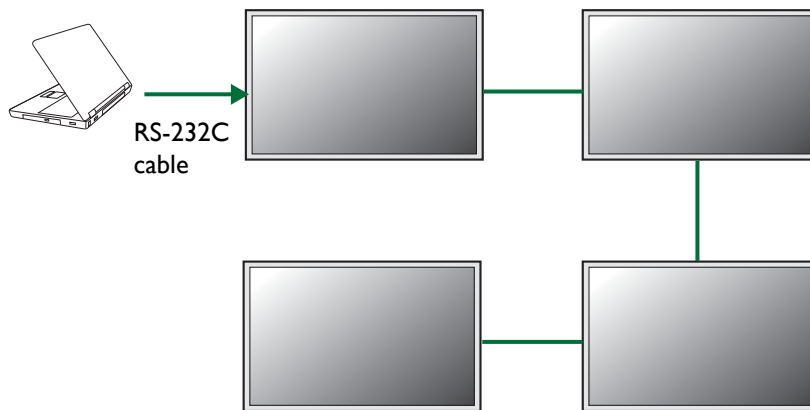

- Use an appropriate RS-232C cable. Refer to the user manual or BenQ service for more information.
- For PL490/PL552/PL553/PH5501/PH5502, choose the RS232 control form Card OPS or embedded RS232 in PD set.

## Management by LAN: PL460/PH460/PL550/PH550

1. Connect the computer to a LAN switch or hub using a RJ45 cable (purchased separately if not supplied).
2. Connect all displays separately to the same LAN switch or hub just connected with your computer using RJ45 cables (purchased separately if not supplied). Now the computer and all displays are within the same local area network.
3. Make sure the network connection is enabled.

4. Go to **Setting > Control Setting** each display. Select **LAN**. Refer to the user manual of the purchased model for the detailed settings and the operation of LAN control.

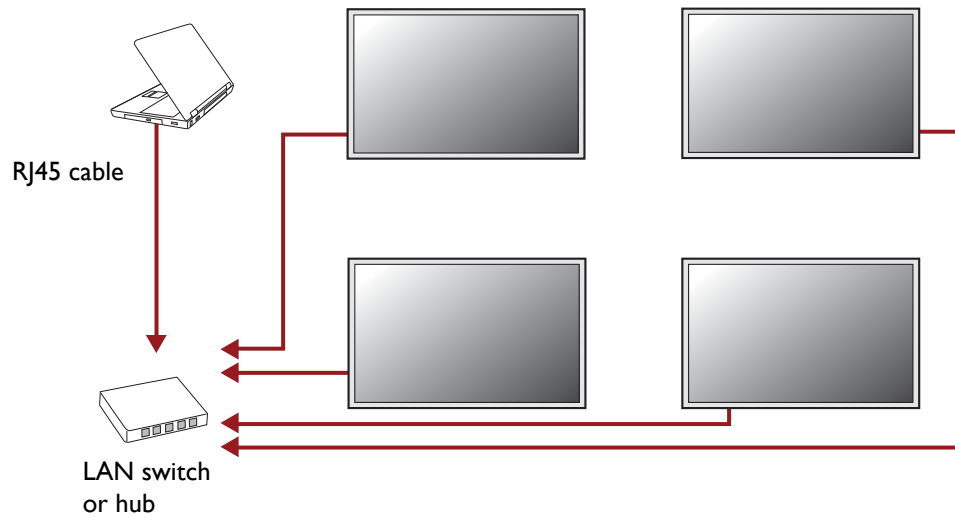





For PL490/PL552/PL553/PH5501/PH5502, there is no need to select **LAN** as it is automatically enabled once the device is connected.

## Optimizing the video wall performance and management: PL460/PH460/PL550/PH550/PL490/PL552/PL553/PH550 I/PH5502

To optimize the video wall performance, change the OSD settings as suggested.

1. Make sure the displays have been looped by IR, RS-232, or RJ45 connection.
  2. Go to **Tiling > Frame Comp.** and set it to **On**.
  3. Go to **General settings > LED** and set it to **Off**.
  4. Go to **General settings > Monitor ID** and set different ID for each display.
  5. Go to **General settings > Switch on delay** and set Auto or delaying time.
- You are provided with BenQ software to fully utilize the video wall management. Visit the BenQ local website for the software and the user manuals.

Software	Description
<b>Multi-Display Administrator (MDA)</b>	<p>A software program that enables remote and centralized management of a single or multiple BenQ digital signage displays on a host computer. You can create and edit display groups, view status of displays as well as change display settings.</p> <ul style="list-style-type: none"> <li> Use an appropriate RS-232C cable. Refer to the user manual or BenQ service for more information.</li> <li> Contact the BenQ customer service center for demonstration videos if needed.</li> </ul>
<b>Color Management</b>	<p>A software program that enhances the image uniformity of all displays in a video wall application. You can also adjust color settings of each display easily on a host computer, or backup and restore calibration data quickly.</p> <ul style="list-style-type: none"> <li> Use an appropriate RS-232C cable. Refer to the user manual or BenQ service for more information.</li> <li> Contact the BenQ customer service center for demonstration videos if needed.</li> </ul>

Software	Description
<p><b>Color Meter</b></p>	<p><b>x-rite, i1 Display</b></p> <p>Part Number:</p> <ul style="list-style-type: none"> <li>• PL460/PH460/PL550/PH550: EODIS3-OEM</li> <li>• PL490/PL552/PL553/SL490/SL550/PH5501/PH5502/PL5502/PL4901/PL5501: EODIS3-DCOE</li> </ul> <p>Software Version:</p> <ul style="list-style-type: none"> <li>• PL490/PL552/PL553/PH5501/PH5502/PL5502/PL4901/PL5501: v.P.I.0.1</li> <li>• SL490/SL550: v.S.I.0.1</li> </ul>  <p>PL490/PL552/PL553/SL490/SL550/PH5501/PH5502/PL5502/PL4901/PL5501</p>

# Operating Instructions of Edge Alignment Kit/Pin: PL490/PL552/PL553/PH5501/PH5502

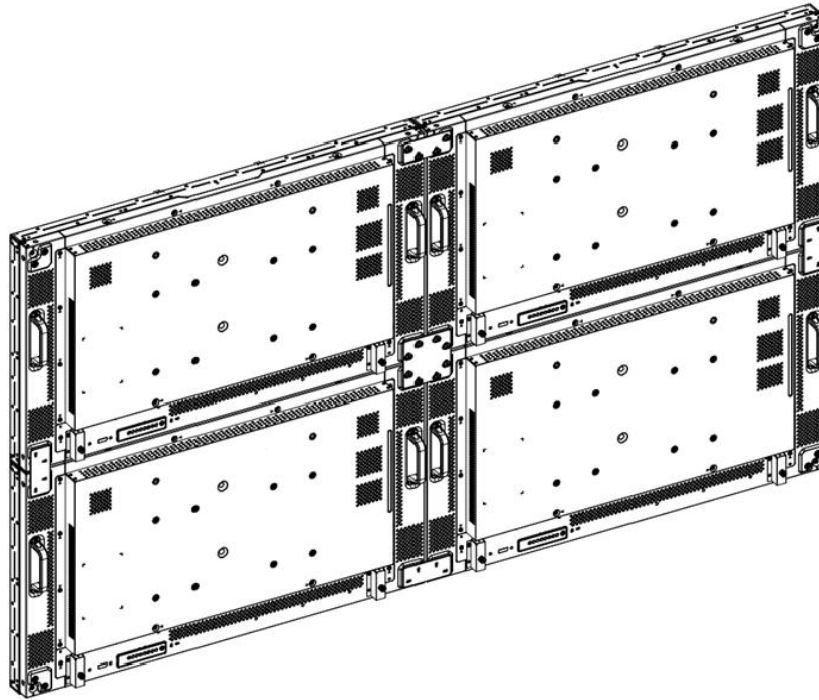

## Basic composition per set

1. Edge Alignment Kit-1: 1PCS
2. Edge Alignment Kit-2: 2PCS
3. Thumb Screw: 8PCS
4. Edge Alignment Pin: 2PCS

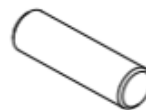
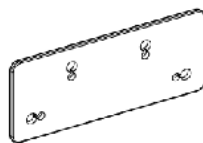
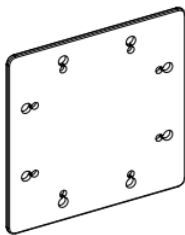

Edge Alignment Kit-1

Edge Alignment Kit-2

Edge Alignment Pin

Thumb Screw



## Function of Edge Alignment Kit/Pin

Keep adjacent Displays at the same plane and uniform gap.



Without using edge alignment kit/pin.

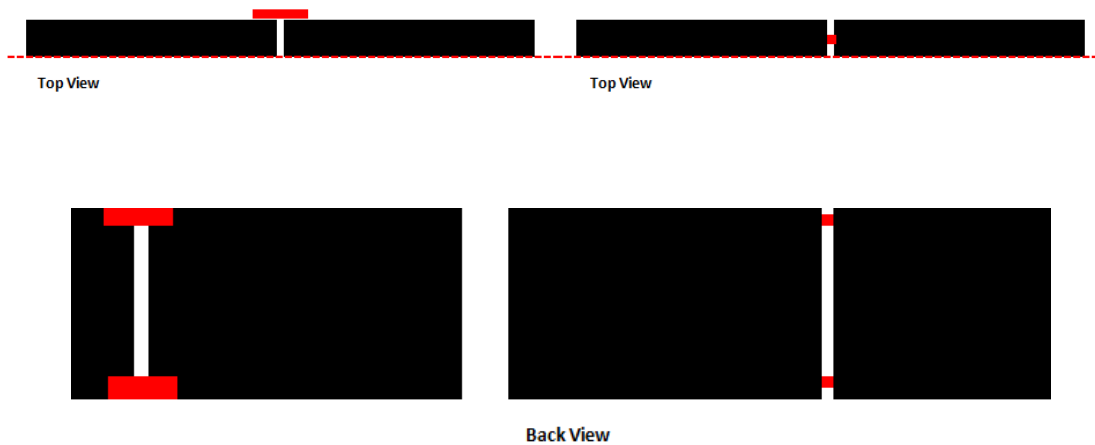

## Installing Edge Alignment Kit

- Before install edge alignment kit, displays must be mounted to video wall frame correctly.
- Using “Thumb Screw” for easy installing.



- Using “Edge Alignment Kit-I” on adjacent four displays.

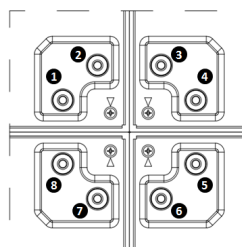

1.

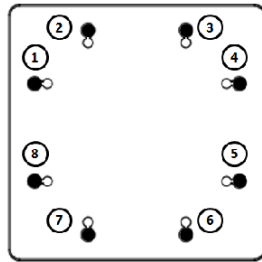

There are two loops of screw holes (outer & inner), depend on the design of each model. (Please check the user manual for using loop information)

- Outer loop: Big screw holes for M6 screw.
- Inner loop: Small screw holes for M4 screw.

2.

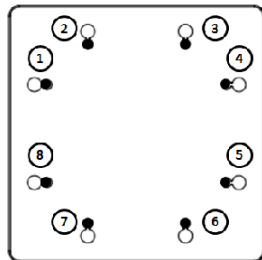

Remark:

- M6 screw: for PL552/PL553/PH5501/PH5502
- M4 screw: for PL490

- Using “Edge Alignment Kit-2” on adjacent two displays.

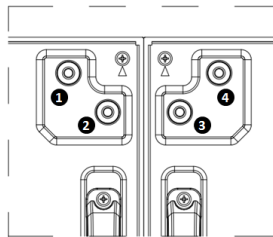

1.

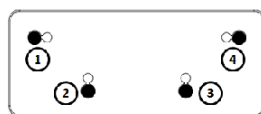

There are two loops of screw holes (outer & inner), depend on the design of each model. (Please check the user manual for using loop information)

- Outer loop: Big screw holes for M6 screw.
- Inner loop: Small screw holes for M4 screw.

2.

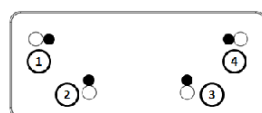

M6 screw: for PL552/PL553/PH5501/PH5502

## Installing Edge Alignment Pin

- During mounting displays to video wall frame, using “Edge Alignment Pin” to secure the flatness of adjacent displays.
- Don't let edge alignment pin to touch the side surface of panel, panel will damage due to incorrect installation.
- Using “Edge Alignment Pin” on adjacent displays.

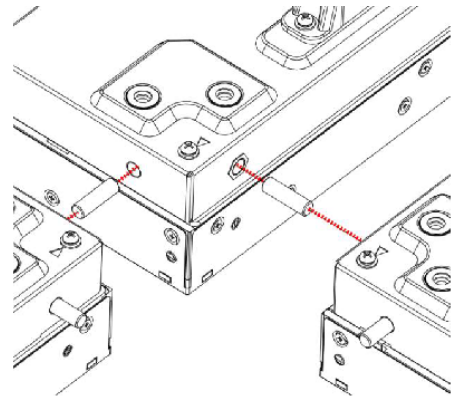
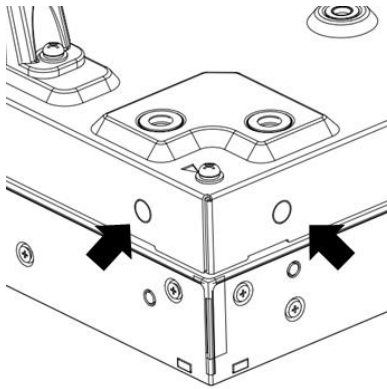

There are 8 holes on the four corners of displays designed for plug-in the edge alignment pin.

## Tiling: PL490/PL552/PL553/PH5501/PH5502

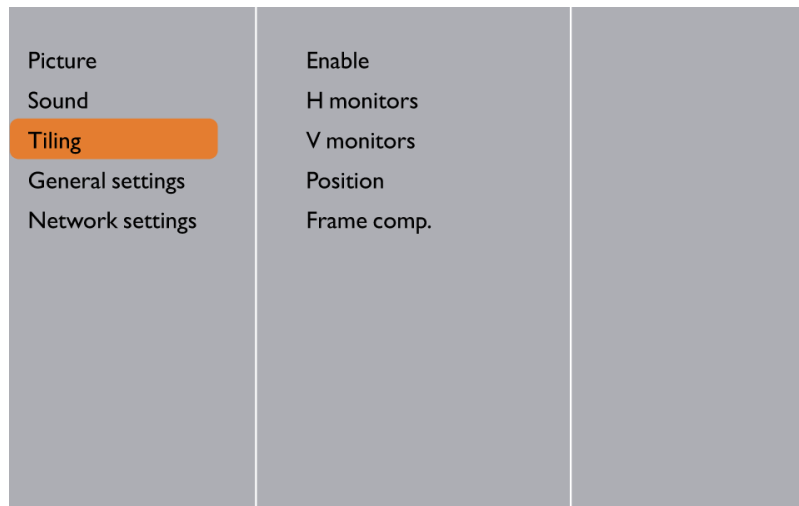

With this function you can create a single large-screen matrix (video wall) that consists of up to 225 sets of this display (up to 15-sets on the vertical and 15-sets on the horizontal sides).

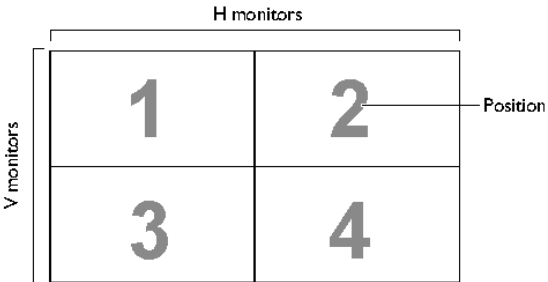
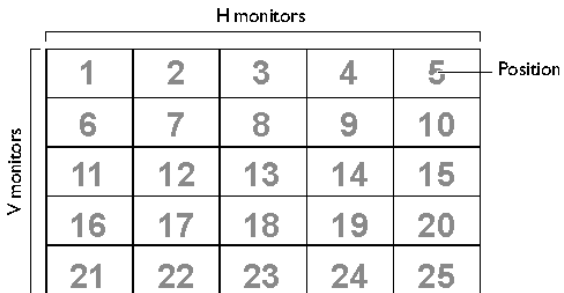
Term	Description/explanation
Enable	Choose to On or Off the Tiling function. If On, the display will apply the settings in H monitors, V monitors, Position, and Frame comp.
H monitors	Adjust displays on the horizontal side.
V monitors	Adjust displays on the vertical side.
Position	<p>Adjust the position of this display in the screen matrix.                      Example: 2 x 2 screen matrix (4 displays)                      H monitors = 2 displays, V monitors = 2 displays</p>  <p>Example: 5 x 5 screen matrix (25 displays)                      H monitors = 5 displays, V monitors = 5 displays</p> 
Frame comp.	Choose to turn the frame compensation function on or off. If selected On, the display will adjust the image to compensate for the width of the display bezels in order to accurately display the image.

## Operating Instructions of Edge Alignment Kit/Pin: PL4901/PL5501/PL5502



Alignment kit x 1

The timing to use edge alignment kit is when the display is already installed and aligned with best effort but still requires slight adjustment, that said to install alignment kit when the adjacent display within less than 0.5mm pitch is advised.

Installed with caution and with advice by experienced installer is required; forcing the display to align by the kit when the display is not properly installed will damage the display, as the display might be bended and can cause damage to the panel.

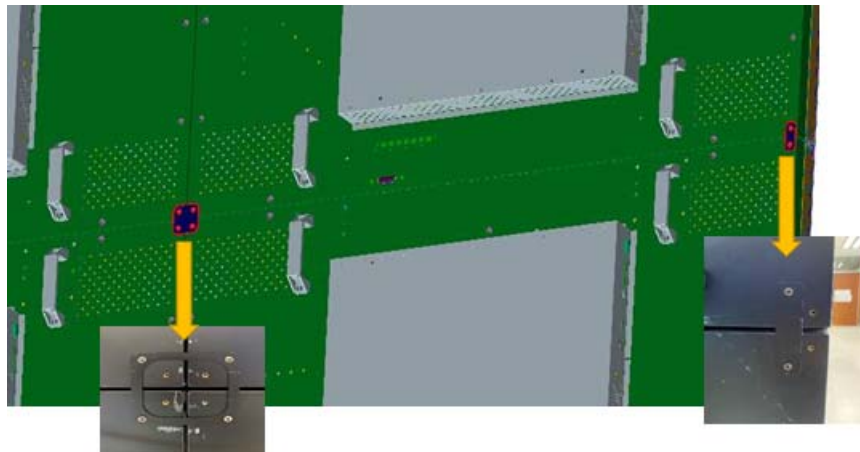

# Tiling: PL490I/PL550I/PL5502

## Video wall

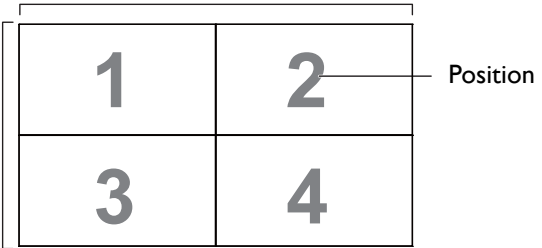
Menu	Description
<p><b>Wall settings</b></p>	<ul style="list-style-type: none"> <li>• Check the unit ID for the current position. Below is an example of 2 x 2 unit ID illustration.</li> <li>• Define the current position and total units of video wall. e.g. H-position: 1, V-position: 1, indicates the upper-left (unit ID 1) display. H total units: 2, V total units: 2, indicates a 2 x 2 video wall.</li> </ul> <div style="text-align: center; margin: 10px 0;"> <p>H monitors</p>  </div> <ul style="list-style-type: none"> <li>• Enable/disable the video wall mode. On: switch display content to its corresponding position in video wall. Off: switch to single display.</li> </ul>
<p><b>Bezel compensation</b></p>	<p>Select ON to initiate compensation.</p>
<p><b>Panel settings</b></p>	<p>Change power on logo procedure:</p> <ol style="list-style-type: none"> <li>1. Save the picture to the USB root folder. The resolution must be 1920 x 1080, and the file must be under 100 KB.</li> <li>2. Insert the USB, then click “Custom logo”.</li> </ol>
<p><b>Scene settings</b></p>	<ul style="list-style-type: none"> <li>• Scene number: Switch between the selected scenes.</li> <li>• Empty/Save: Check if there is a saved or existed scene.</li> <li>• Apply Scene: Click to apply the current scene.</li> </ul>

## Setting the display position for special video wall layout

If a special layout is requested, you will need an additional software and device (purchased separately) for advanced settings. Refer to the user manual of the purchased software for more information.

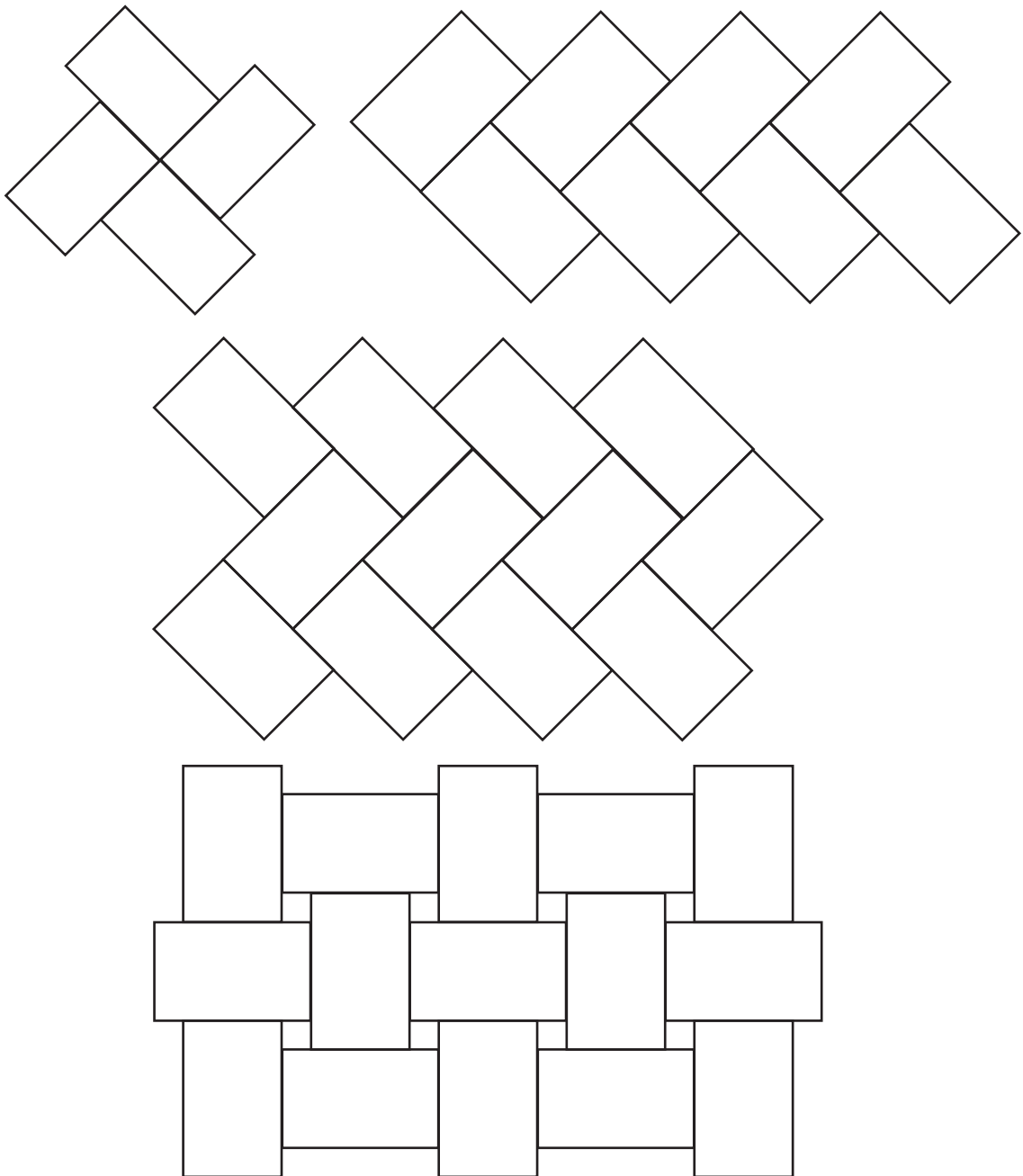

# Special signage installation guide

## D series Full HD 55-inch dual-side display

This guide provides additional information about how to install D series Full HD 55-inch dual-side display. The dual-side display offers users access to information from both sides of the panel. They can be hung from a ceiling, built into walls, or suspended.

### Installation notice

- Identify the FRONT SIDE by finding the barcode. The barcode is near the front side.

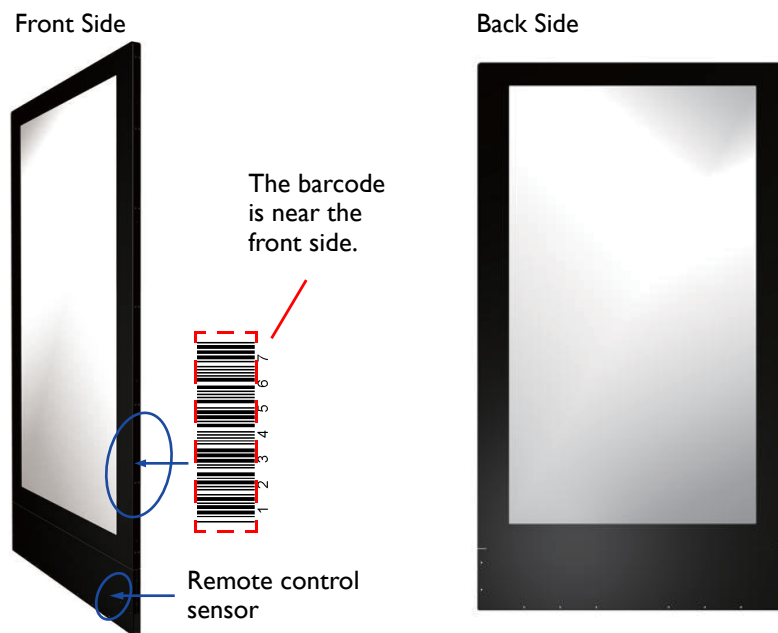

- To make the input source work, the front side should always be connected FIRST before the back side.

### Playing the display

1. Always set the front side the display 1 and the back side the display 2.
2. There are two ports for media players. Try the other side of the display if the player doesn't start.
3. When using a computer, set the display to extension mode.
4. You need two different player software to have both sides of the display work at the same time (e.g., Windows Media Player and RealOne Player). Each side needs a different player.



## Connecting HDMI cables and connectors

Plug two HDMI cables into the cabinet, and ensure that all cable plugs are firmly fitted into the jacks. The main signal input source is HDMI 1. Make sure HDMI 1 is well connected before connecting HDMI 2.

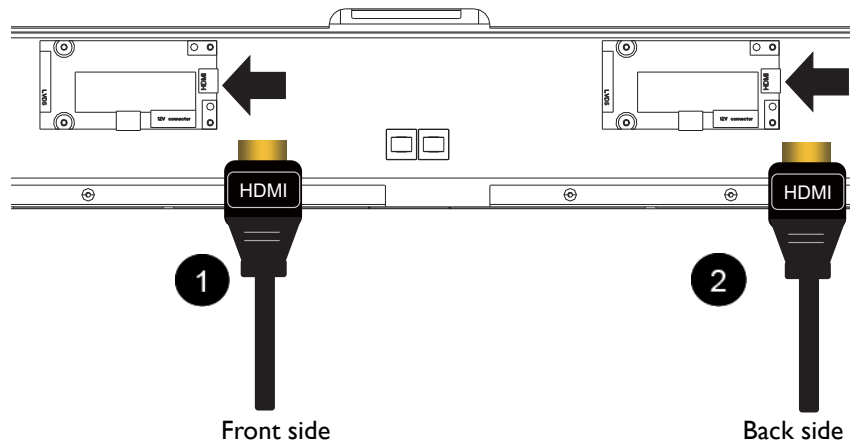

## Connecting the power cord

Plug in the power cable and turn on the AC power switch.

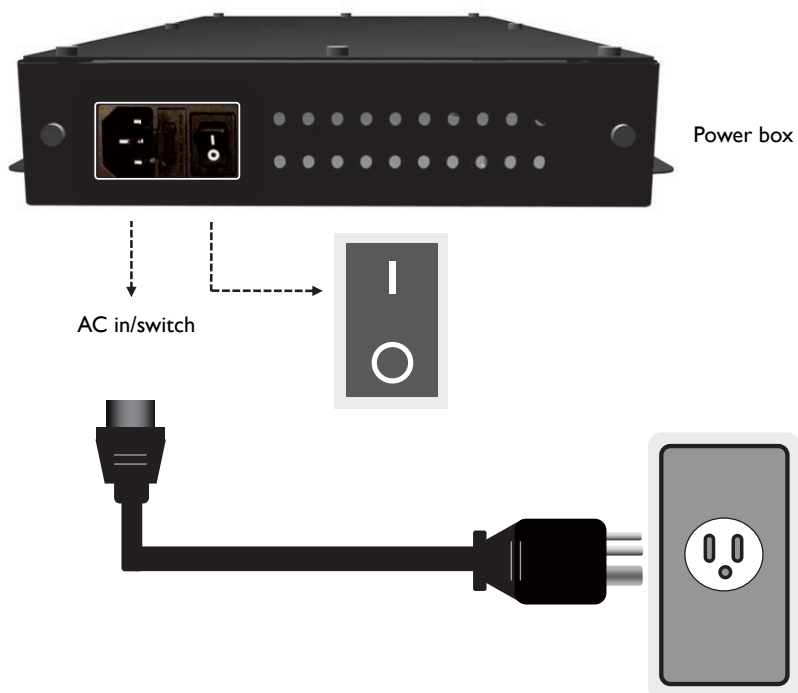

# Connecting the cables

If the display doesn't work, unplug and re-plug the cables. Make sure the cables are plug-in HORIZONTALLY and COMPLETELY.

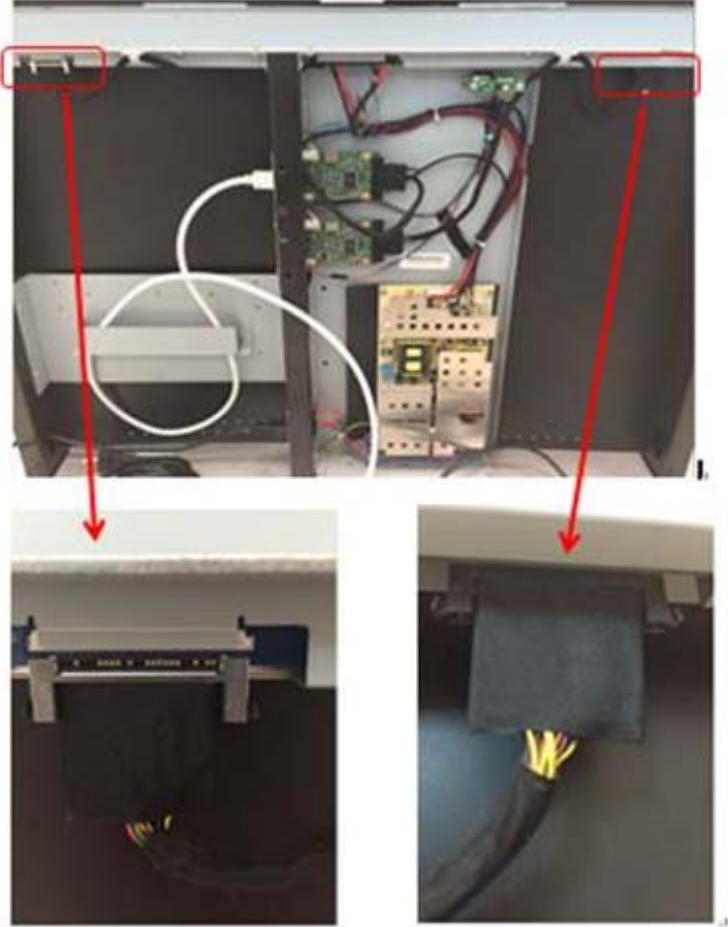

# Mounting installation

For DH55 IF, three mounting options are available: [Ceiling Mount on page 51](#), [U-Mount on page 56](#), and [H-mount on page 60](#).

## Ceiling Mount

### Tools needed



Power drill



Drill head



Hammer



Wrench 12mm



Allen wrench 5mm/  
6mm



Phillips



Pencil

### Secure bracket to ceiling

1. Identify types of the target ceiling: Concrete or wood.



DO NOT secure the bracket to any decorative post or plasterboard for wood ceiling.

2. Drill holes of diameter 10mm and depth 55mm in concrete ceiling with power drill. Please select expansion screws according to types of the ceiling. The expansion screws (B) come with your product are designed for cement wall only. Screws for wood ceiling installation shall feature adequate strength and validated by qualified technicians.

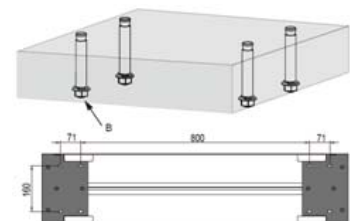
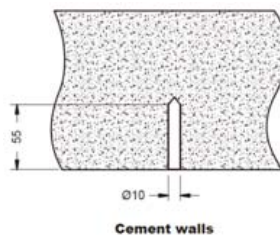
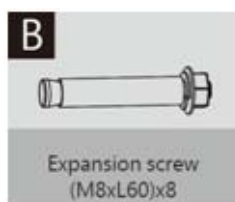

3. Hammer the expansion screws (M8xL60) (B) in the holes drilled earlier and tighten their nuts.

- Remove the flat head screws (M3xL8) (C) with a Phillips screwdriver before pulling open the plastic cover to the left and right.

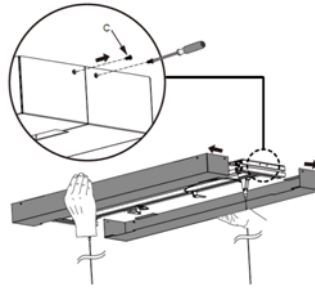
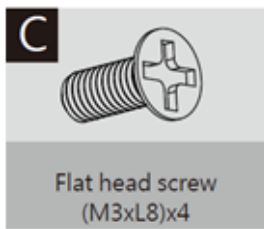

- Remove the spring washer and nut from the expansion screw and secure the bracket (A) to the ceiling.



Places washers in sequence as shown below when securing the bracket to ceiling: Bracket (A) => spring washer => nut

## Install panel display to the bracket

Secure the display frame (E) to the display with the included flat head screws (M4xL10) (D) by a Phillips screwdriver.

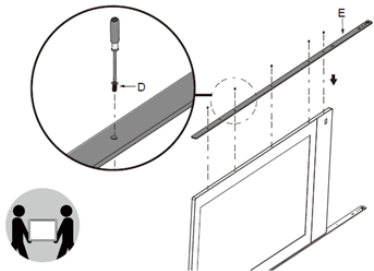
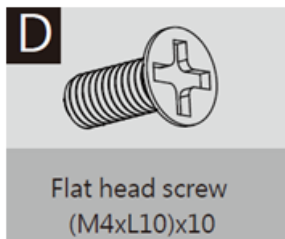

## Secure device box to the bracket

- Remove flat head screws (M3xL8) (C) with a Phillips screwdriver before removing the front cover of the device box (F).

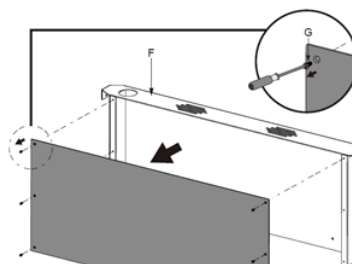

- Secure the display box (F) to the display with the included flat head screws (M3xL8) (C) by a Phillips screwdriver.

3. Lead cables out of outlet at bottom of device box for cabling.

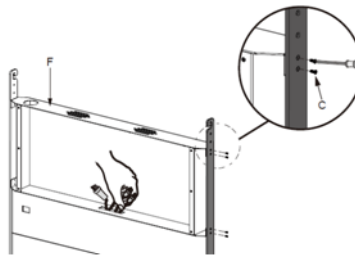
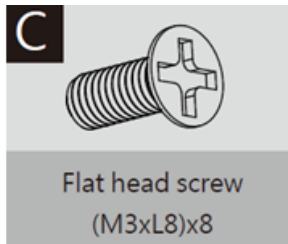

4. Secure the front cover of the device box (F) to the later with the included flat head screws (M3xL8) (C) by a Phillips screwdriver.

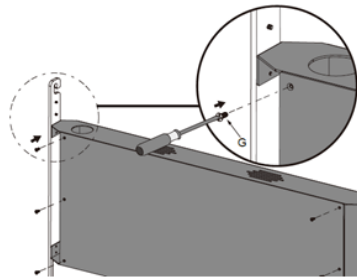

## Adjust cable length

1. Leave appropriate cable length by winding the excessive section around the cable slot.

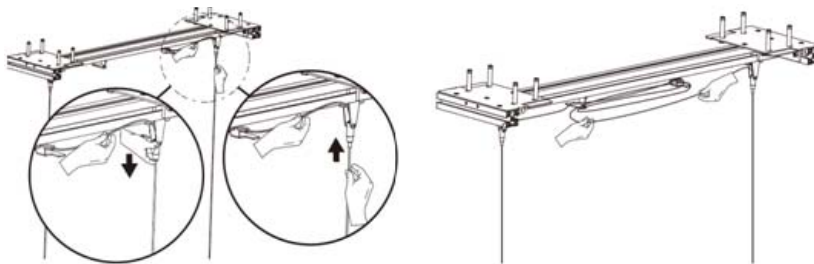

2. Replace the plastic covers to the left and right of the bracket before securing them with the included flat head screws (M3xL8) (C) by a Phillips screwdriver.

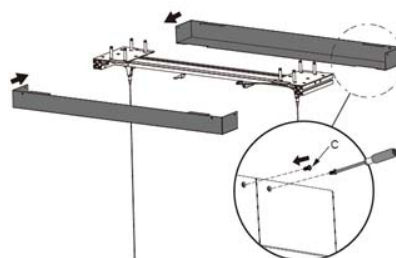

## Secure panel display to the bracket

1. Secure panel display to the bracket.



2. Secure the bracket to the panel display with the included flat head screws (M4xL10) (D) by a Phillips screwdriver.

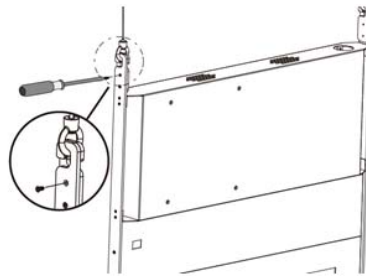
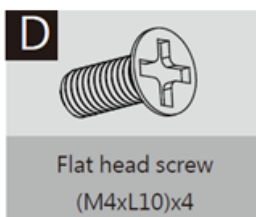

## Protect with spiral wraps

Shield cables with spiral wraps.

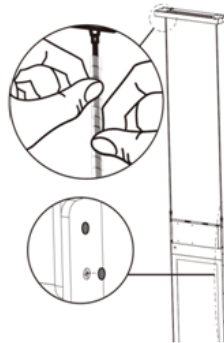

## Notice

1. Always set the front side the display 1 and the back side the display 2.
2. When using a computer, set the display to extension mode.
3. You need two different player software to have both sides of the display work at the same time (e.g., Windows Media Player and RealOne Player). Each side needs a different player.
4. Due to the size and weight of this display, it is recommended to move it with at least two persons.
5. Power function of the remote controller works only when pointing to the front side of the display; the other functions work at either side.

6. When turning off the display by disconnecting the power cable or DC power cord, wait for 6 seconds before reconnecting the power cable or DC power cord for normal operation. To protect your display from possible damage, do not put excessive pressure on the display.
7. Don't block the ventilation holes on the power box. It is prohibited to turn the ventilation hole of Power Box upside down. It is prohibited to place tilt.
8. Ensure the use of an approved power cord provided by BenQ at all times. If your power cord is missing, please contact your local service center.
9. Provide an earthing connection before the mains plug is connected to the mains. And, when disconnecting the earthing connection, be sure to disconnect after pulling out the mains plug from the mains.
10. Unplug the display if you are not going to use it for an extensive period of time.
11. Unplug the display if you need to clean it with a slightly damp cloth. The screen may be wiped with a dry cloth when the power is off. However, never use organic solvent, such as, alcohol, or ammonia-based liquids to clean your display.
12. If a foreign substance or water gets in your display, turn the power off immediately and disconnect the power cord. Then remove the foreign substance or water.
13. Don't store or use the display in locations exposed to heat, direct sunlight, or extreme cold.
14. > 4.5m height is recommended, otherwise will be crowded.
15. Drawing of Ceiling Mount

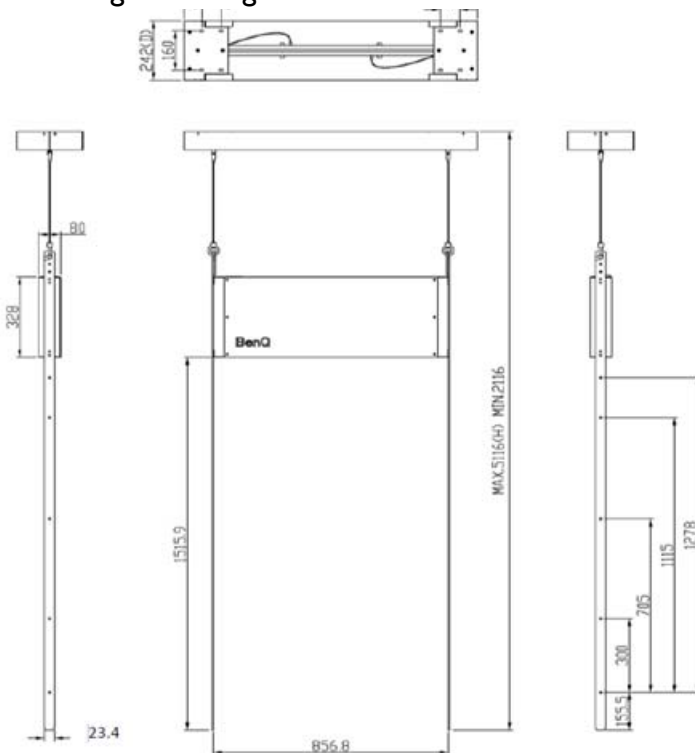

# U-Mount

## Tools needed



Power drill



Drill head



Hammer



Phillips screwdriver



Pencil

## Pre-action: secure bracket to a wall

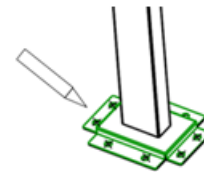
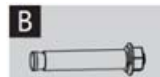
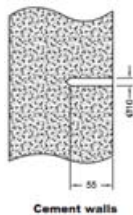

1. Please identify the type of the target wall: Concrete or wood.
2. Please drill holes of diameter 10mm and depth 55mm in concrete walls with power drill at locations you have marked earlier. Please select screws according to the type of the wall. The expansion screws (B) that come with your product are designed for cement walls only. Screws for wood wall installation shall feature adequate strength and be validated by qualified technicians.
3. Hammer the expansion screws (M8xL60) (B) in the holes drilled earlier and tighten their nuts.



- DO NOT secure the bracket to any decorative post or plasterboard for wood walls.
- Before drill the hole, use Pipe TOP and BOT to mark hole location on center line by pencil.



## Installation steps

### Step 1: Threading the cables through Pipe TOP and Frame

1. Shielding two power cables and also 2 HDMI cables
2. Threading the HDMI & Power cables through 2 Pipe TOPs (mark blue)
3. Threading the cables through the frame (mark orange)

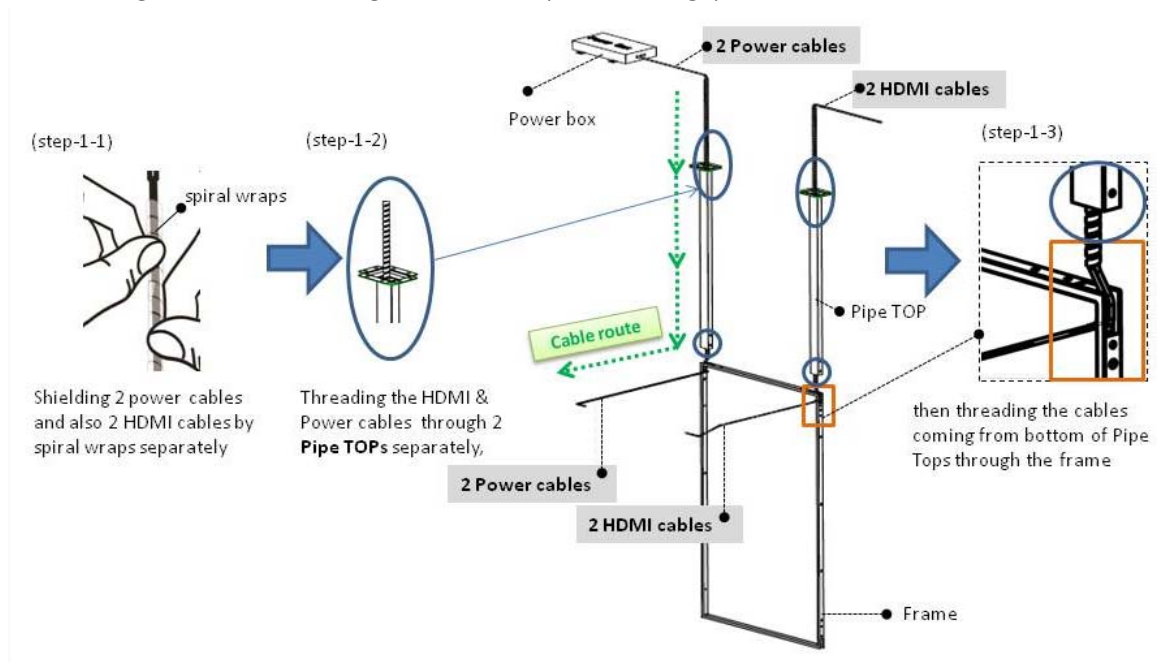

### Step 2: Set-up the display for installation

1. Putting the display front side up
2. Removing I/O covers at the sides
3. Removing the downside cover

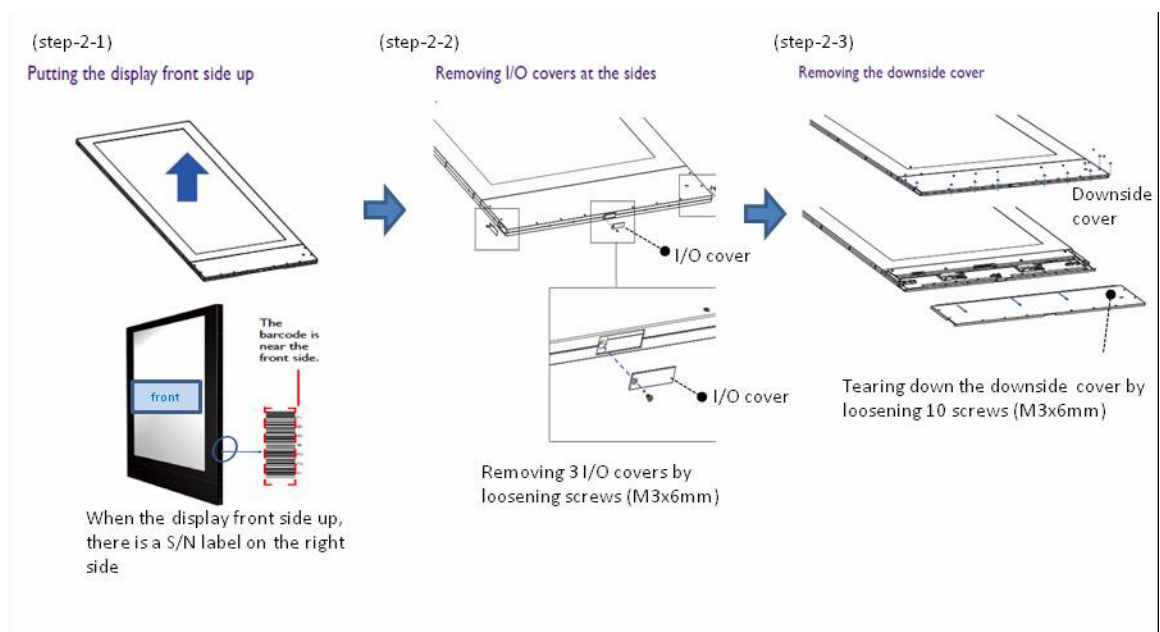

### Step 3: Connecting the Power cables & HDMI cable with double sided panel

1. Connecting the Power cables
2. Connecting the HDMI cables
3. Screwing the downside cover back

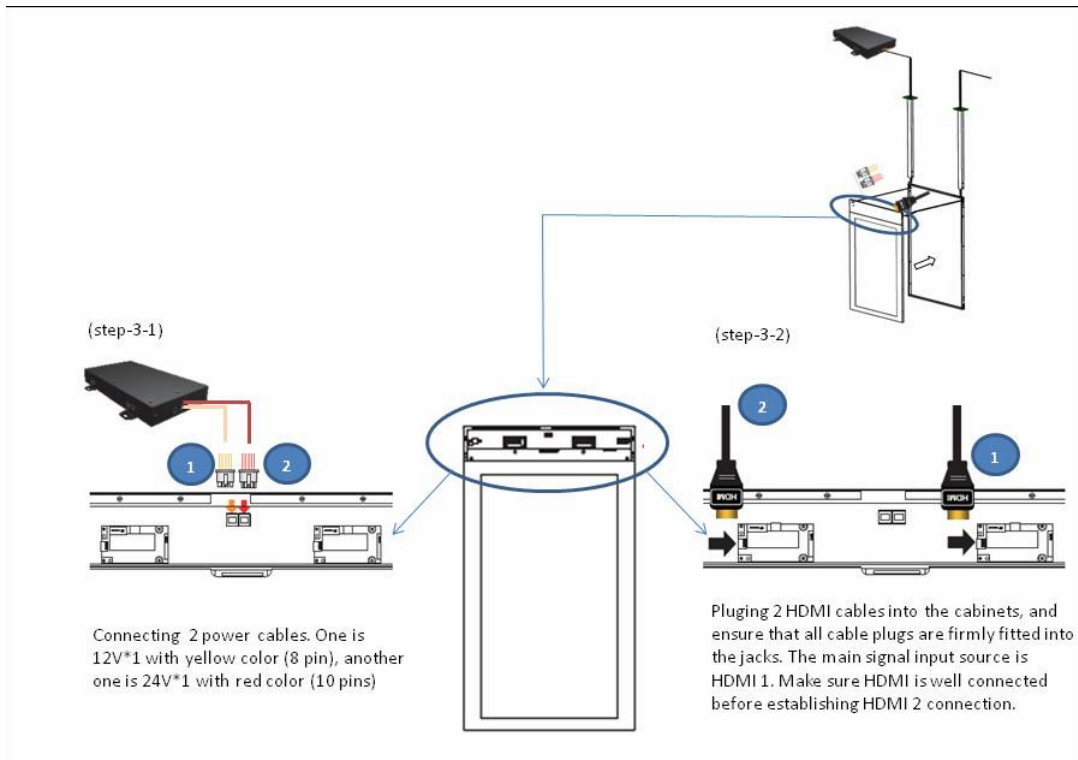

### Step 4: Fixing the double sided display with Frame

1. Putting the double sided display into the Frame
2. Then, fixing them by screws

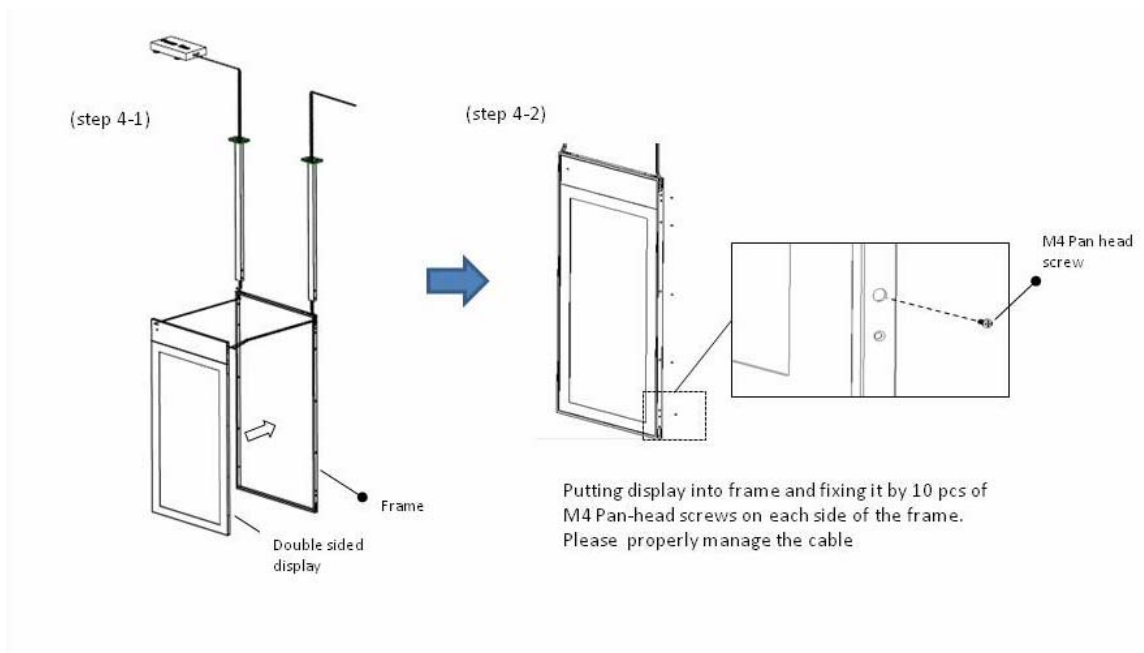

## Step 5: Installing both Bracket L and Bracket corner on the frame at four corners

1. Installing Bracket L
2. Installing Bracket corner
3. Repeating the same actions at four corners

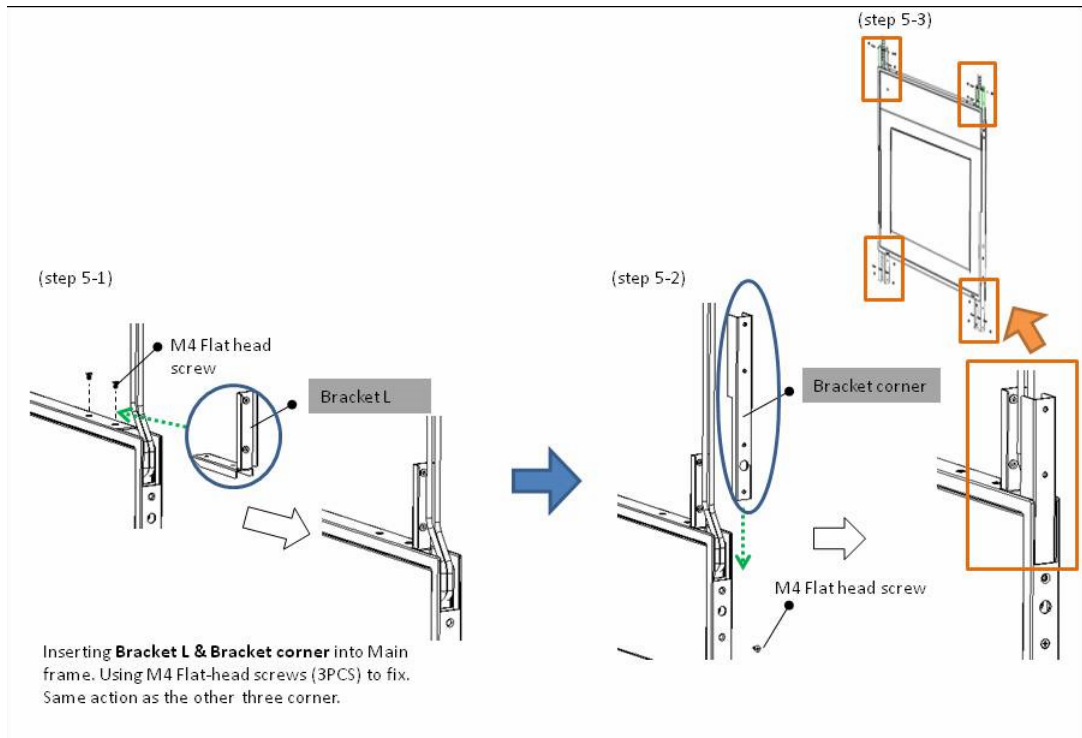

## Step 6: Assemble Pipe TOP and Pipe BOT

1. Assemble Pipe TOP and Pipe BOT
2. Fix 4 Cover plates

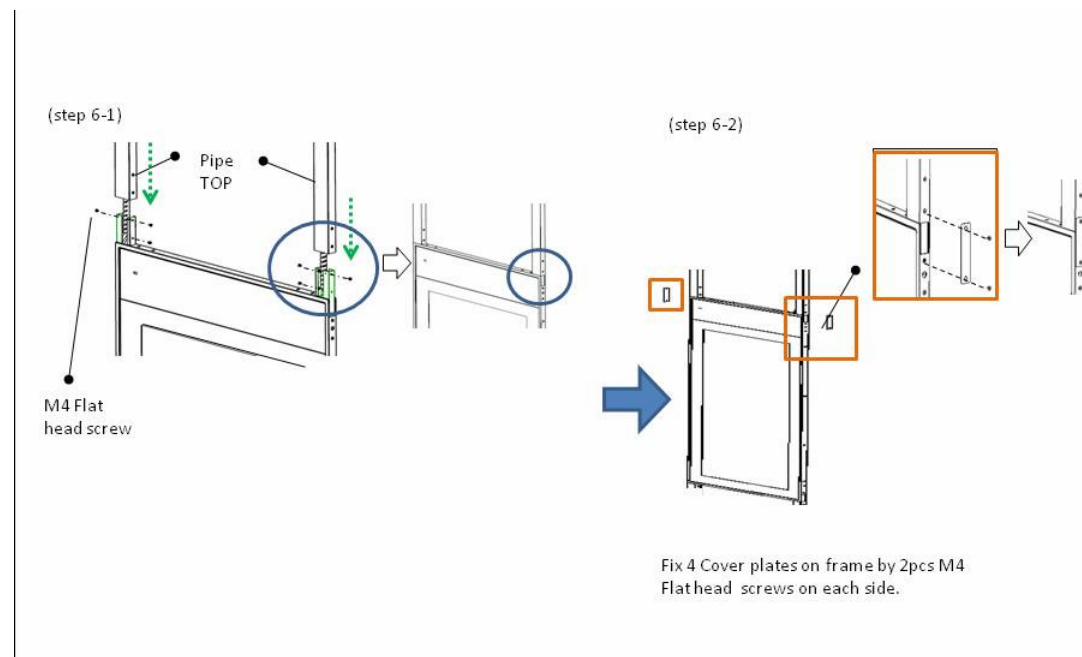

# H-mount

For tools needed, pre-action, and installation steps 1-5 of H-mount, please refer to [U-Mount on page 56](#). For steps 6-7 of H-mount, please read the following.

## Step 6: Assemble Pipe TOP and Pipe BOT

1. Assemble Pipe TOP and Pipe BOT
2. Fix 4 Cover plates

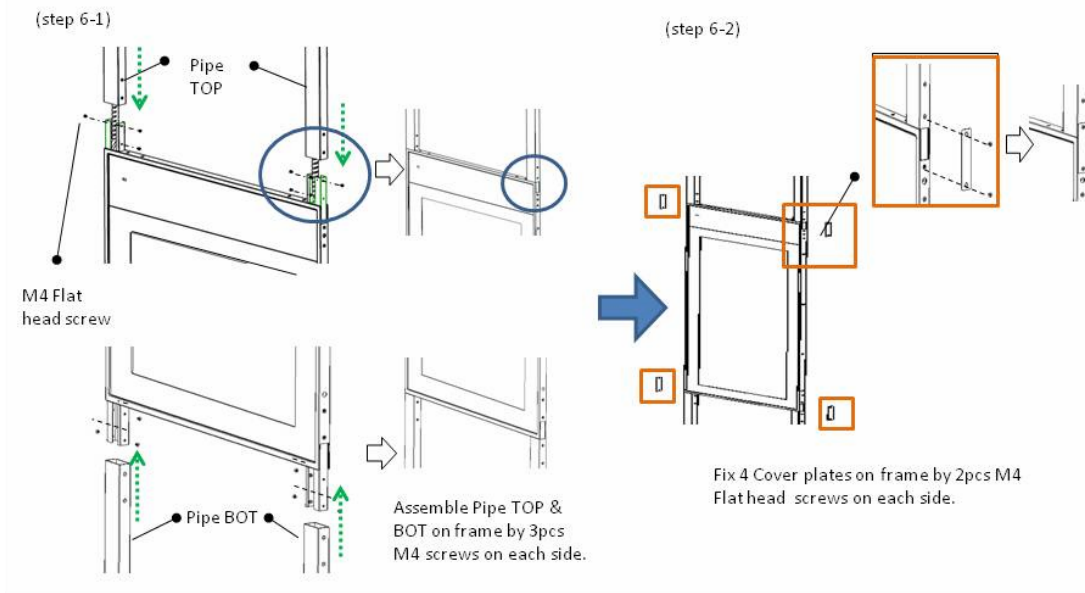

## Step 7: Mounting Pipe TOP and Pipe BOT with ceiling and ground

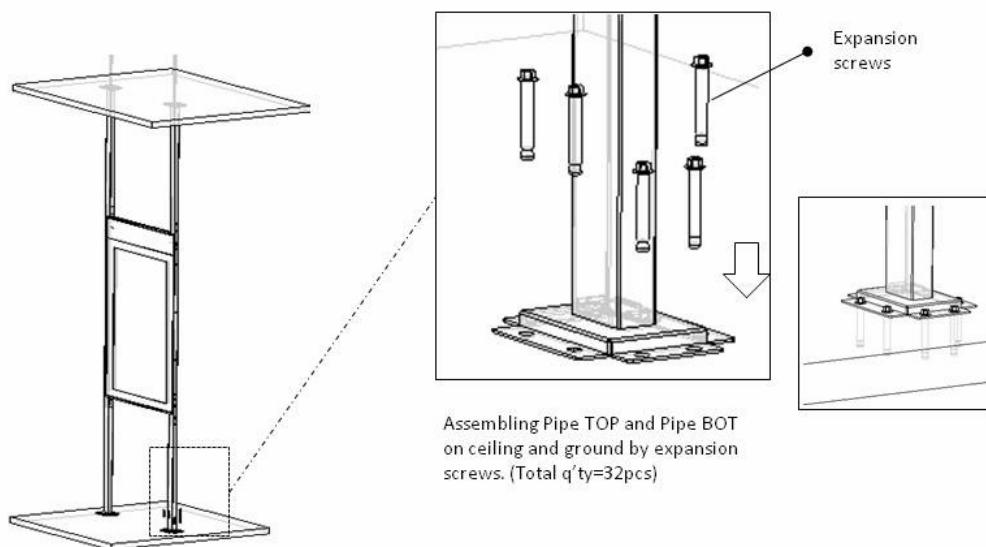

# Digital Signage Bar-Type Series

The bar type display panel is a long structured design panel. Designed with a slim form factor, the display panel can be used in small or large spaces to display everyday information.

## Installation notice

- When the display is connected to the PCs or laptop, it is at its native resolution.

Model	Native Resolution (pixels)
BH240I/BH240IT	1920 x 190
BH350I/BH350IT	1920 x 130
BH280/BH281/BH280I/BH280IN	1920 x 360
BH380	1920 x 545
BH380I/BH380IN/BH380ID	1920 x 600

- Set the display to the projector mode. The picture will be displayed with full screen.
- If the aspect ratio of the picture is the same as that of the display, the picture can be fully shown without distortion.

Position	Description
Top	The window is positioned to the top 1/3 of the screen.
Bottom	The window is positioned to the bottom 1/3 of the screen.
Middle	The window is positioned to the middle 1/3 of the screen.
Zoom Out	The full screen is compressed into the window.
Zoom In	<ul style="list-style-type: none"> <li>• When the window is positioned to the top 1/3 of the screen, the input image zooms in 3%.</li> <li>• When the image is on the top and does not fill the screen, you can choose this position to present the best effect.</li> </ul>

## Adjusting the OSD setting: For BH280/BH281/BH380

The resolution can be adjusted to 1920x1080. You can make the following display effects by adjusting the OSD setting.

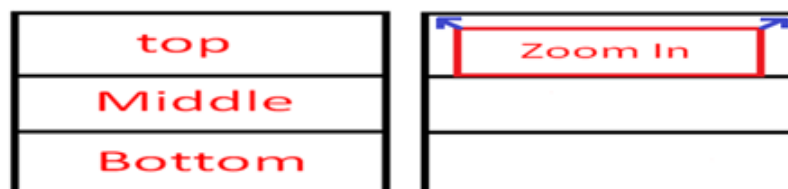

- If the input source is not 1920x1080, only Zoom Out can be selected.

- Frequency : Frequency narrows or widens the screen.

## BH series HDMI connection (EXCEPT BH280/BH281/BH380)

### HDMI in connection

Connect the BH series with PCs or laptop, go to **Windows Setting > Display** and choose the BH series as an extension display. In the following methods, we use BH380I (1920 x 600) as an example.



BH240I/BH350I are only applicable with method 2.

Method 1: Content is customized to the corresponding resolution 1920 x 600.



1. In **Windows Setting > Display > Advanced display setting**, select the BH380I and choose 1920 x 600 as resolution setting.
2. On BH380I, users can either choose **Full** or **1:1** in **Display > Zoom mode**.

If the 1920 x 600 content is not allocated at the right ratio, it is caused by frequently switching between resolutions, and the setting in the video graphics card goes wrong.

1. Please go to **Windows Setting > Display > Advanced display setting > Display adapter properties**.

2. Change the **screen refresh rate** to 60Hz in **Monitor** section. The content should be allocated at the right ratio.

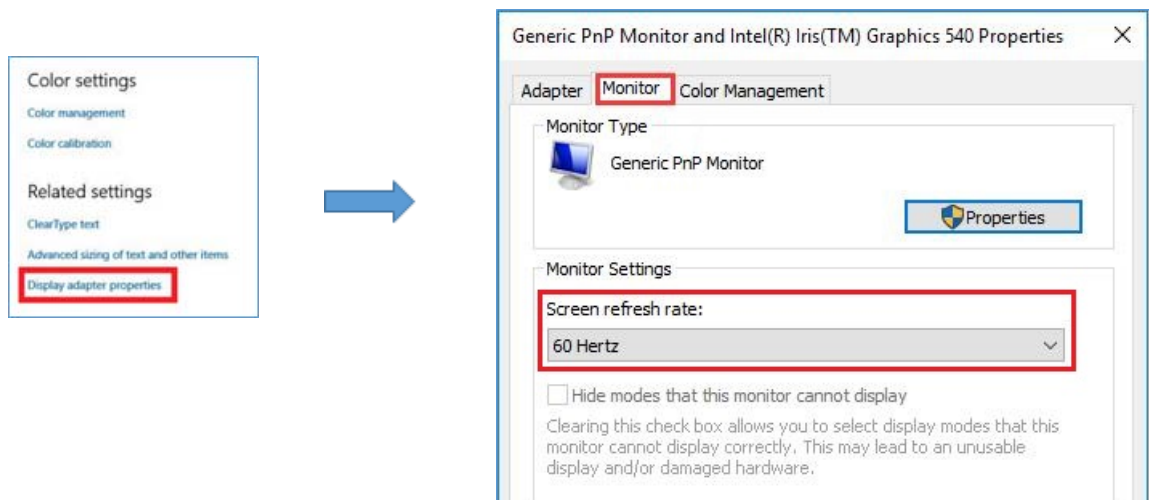

Method 2: Content is in the upper section of 1920 x 1080

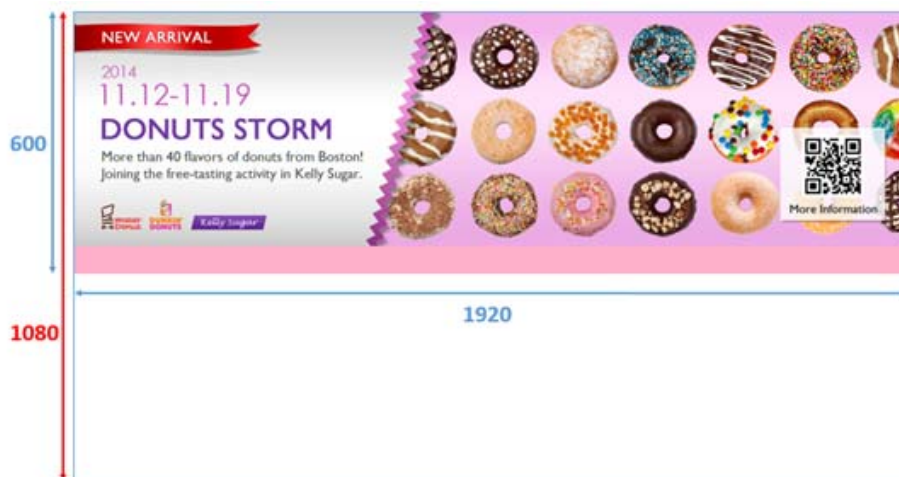

1. In **Windows Setting > Display > Advanced display setting**, select the BH3801 and choose 1920 x 1080 as resolution setting.
2. On BH3801, choose **1:1** in **Display > Zoom mode** to correctly display the content.
3. To proceed further Windows control, choose **Full** in **Display > Zoom mode** to gain full screen access on BH3801.

# Digital Signage Rotation/Portrait Guide

Model	X-Sign	Android	Correct Heat Dissipation
ST4302 ST5502			
SL4302K SL5502K SL6502K			
SL7502K SL8502K			

 IR Sensor Location





? How to connect a computer to the display?

✓ You can connect a computer to the display through D-Sub (VGA)/DVI/HDMI/VGA as desired.

### Analog signal

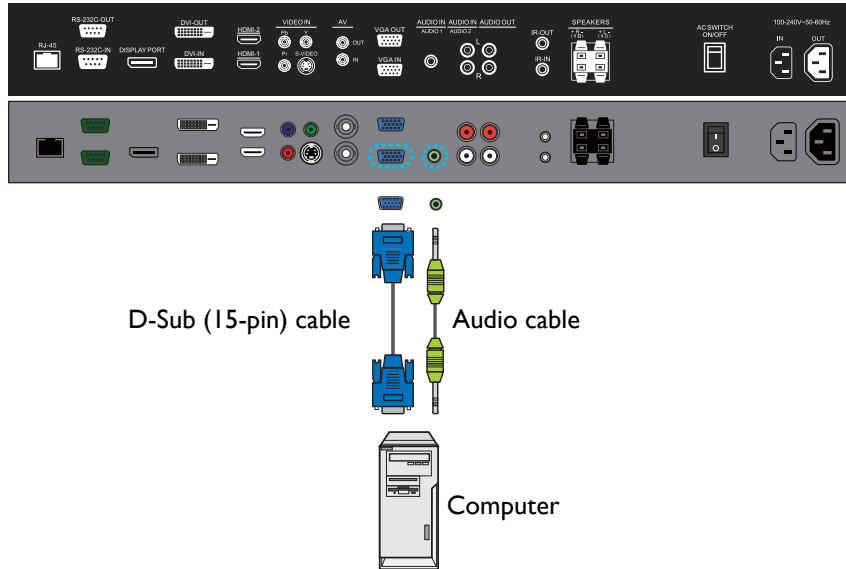

### Digital signal

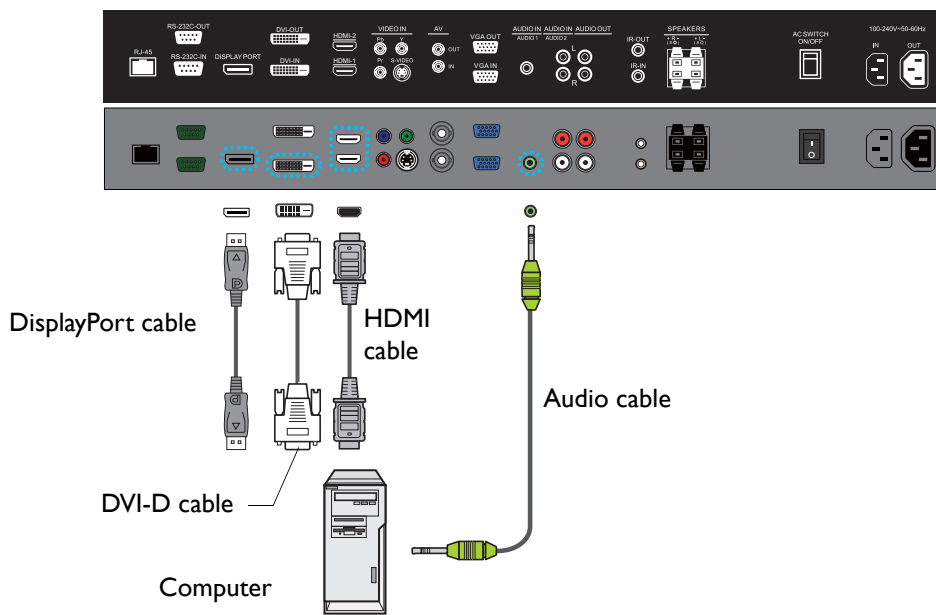

? How to connect to external speakers?

✓ While the display is turned off, connect external speakers to the **SPEAKERS (R/L)** jacks on the display via an appropriate audio cable. And then turn on the display.

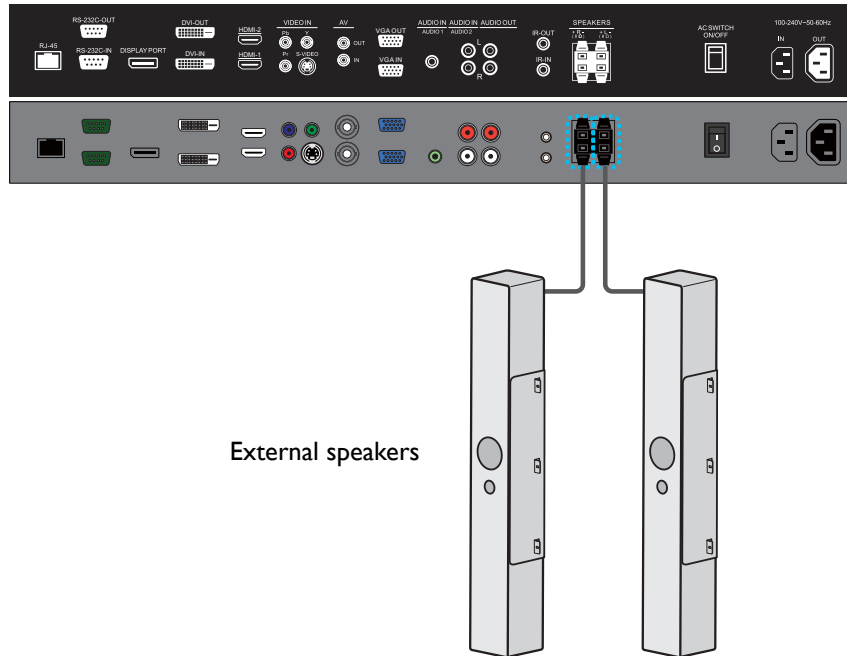



## Picture/video

 No picture is displayed.

 Possible causes	Possible solutions
The power cord is not connected.	Re-connect the power cord.
The main power switch on the back of the displayed is not switched on.	Make sure the power switch is switched on.
The selected input is not connected.	Depending on the selected input, connect the display with the input source using the appropriate cable(s).
The display is in Standby mode when the input source is D-Sub (VGA).	Check the cable connection. See the user manual for details.
Incorrect cable connection.	Press any of the control panel (keypad) buttons and check if the OSD menu could be displayed. If yes, the problem lies somewhere else.
	Try with another display resolution or another graphic card (GPU).
	Restore the display to the default factory settings.
The main board could be damaged.	Contact the BenQ authorized service partner for replacement.

 Screen interference is observed or noise is heard.

 Possible causes	Possible solutions
This could be caused by other appliances, traffic, or fluorescent lights in the surroundings.	<ul style="list-style-type: none"> <li>• Go to <b>Picture &gt; Noise Reduction</b>.</li> <li>• Move the display to another location to see if the interference is reduced.</li> </ul>
Poor quality cable is used for signal input.	Try with another video cable.

 The image has a faulty coloration.

 Possible causes	Possible solutions
The video cable is not connected properly.	Make sure the video cable is connected firmly to the display.

? The picture is distorted with strange patterns.

✓	Possible causes	Possible solutions
	The video cable is not connected properly.	Make sure the video cable is connected firmly to the display.
	The image format is not supported by your display.	Check the specifications to verify the display's supported formats.

? The picture does not fill up the full screen when the input source is D-Sub (VGA).

✓	Possible causes	Possible solutions
	The picture is not properly zoomed.	Go to <b>Screen &gt; Aspect &gt; Wide Zoom</b> or <b>Zoom</b> to adjust the display's geometry and time frequency parameters. Refer to the user manual for more information on the menu options.  Note the picture may be distorted or stretched if fitted to the screen.





? You are running the display at its native resolution, but the image is still distorted.

✓	Possible causes	Possible solutions
	Images from different input sources may appear distorted or stretched on the display running at its native resolution.	Go to <b>Screen &gt; Aspect</b> to set a proper aspect ratio for the input source.

? Sound can be heard but no image is displayed.

✓	Possible causes	Possible solutions
	The video cable is not connected properly.	Make sure the video cable is connected firmly to the display.
	(If the input is HDMI) Poor cable quality.	Try with another HDMI cable.

 The picture unstable, unfocused, or swimming.

-  • Make sure the video cable is connected firmly to the display.
-  • Go to **Screen > Adjust Screen** to focus and adjust the display. Try with **Auto Adjustment** first to adjust the settings automatically. If it does not help, you can make adjustment manually. Once the display mode is changed, you may need to adjust the screen again.
-  • Check if a supported timing is set. On your display, press **INFO** on the remote control to find out the current resolution and timing. Alternatively, you can check the information from your computer. The way to check the timing may differ by operating system. Refer to the help document of your operating system for details.
-  • Try with another video cable.

 Does my display support PIP (Picture in Picture) function?

 Yes, but the availability of PIP function also depends on the video sources. Refer to **Supported PAP input signal combination** in the user manual of the purchased model for details.



The PIP function will be disabled if the video wall or the touch function is in use.

 The picture is not displayed in the center of the screen when the input source is D-Sub (VGA).

 Go to **Screen > Adjust Screen** to make adjustment.

For advanced setting, change the setting under **H. Position** and **V. Position**. See the user manual of the purchased model for more information.

In **H. Position**, press **▶/+** on the control panel to move the picture to the right; press **◀/-** to move the picture to the left.



In **V. Position**, press **▶/+** on the control panel to move the picture up; press **◀/-** to move the picture down.

 What are the supported resolutions of my display?

 The supported resolutions may differ by model. Refer to **Supported input signal resolution** in the user manual of the purchased model for details.

 What is the recommended refresh rate?

 The recommended refresh rate for your display is 60 Hz.

-  The display flickers when I launch or close a program.
- 
  - The signal may not be stable. Check the cable connection or try with another video cable.
  - The panel backlight may be unstable. Contact the BenQ authorized service partner for replacement.

## Audio

-  The image is displayed but no sound is heard.

 Possible causes	Possible solutions
Your graphic card driver is not installed or updated.	Update the driver through <b>Windows Update</b> (for Windows Operating Systems) or the graphic card's manufacturer.
The audio cable is loose.	Power off the display and re-connect the audio cable. Power on the display again.
Not external speakers are connected.	Connect external speakers to the display and adjust the volume appropriately.
The audio output device is not consistent with the display setting.	Make sure the setting in <b>Speaker</b> on your display is the same with the audio output device.
Either the display's or PC's Speaker has been muted.	Disable mute by pressing the <b>MUTE</b> button on the remote control.
The main board could be damaged.	Contact the BenQ authorized service partner for replacement.
(If the signal source is HDMI/DP)	
The <b>Speakers</b> in your OS is not set properly.	Set DisplayPort or HDMI as the default speaker in your operating system and launch the media player again.
Your display's audio input is not set to <b>DisplayPort</b> or <b>HDMI</b> .	Set the <b>Audio Source</b> of your display to <b>DisplayPort</b> or <b>HDMI</b> .



## Remote control

-  The remote control does not work.

 Possible causes	Possible solutions
The remote control does not work.	Refer to <a href="#">Notes on using the remote control on page 8</a> .
The battery drained out.	Replace with a new battery.
The remote control is damaged.	Try with a new remote control.
The IR receiver could be damaged.	Check if the LED indicator of the IR receiver lights red or does not light up. If so, contact the BenQ authorized service partner for replacement.
It is out of the IR remote control range.	Check the specifications and adjust the distance between the remote control and the display.

## Touch function (selected models only)

 The touch function does not work.

	Possible causes	Possible solutions
	The touch function is not supported by your OS.	Check the user manual for the supported operating systems.
	The touch driver is not installed.	Visit the BenQ local website for the appropriate driver files.
	No stable or enough power supplied for your computer.	<p>The touch module needs to get enough power supply from your computer to work well.</p> <ul style="list-style-type: none"> <li>• Try with another computer.</li> <li>• Disconnect all the other USB peripherals.</li> <li>• Add a power hub that helps supply more power to your computer.</li> </ul>
	The touch sensor is covered by dust.	<p>Clean the touch sensor properly.</p> <ol style="list-style-type: none"> <li>1. Be sure to turn off the display and unplug the power cord before you clean the screen.</li> <li>2. Remove dust or dirt from the screen and the infrared plastic filter periodically. It is suggested using a small amount of alcohol to clean the infrared plastic filter.</li> <li>3. Moisten a clean, soft, lint-free cloth with a neutral detergent and then clean the touch screen.</li> </ol> <p> Use a neutral detergent to clean the touch screen. Avoid using detergents with erosive substance, such as banana oil or ammonia. To avoid damage to the screen, never use any type of abrasive materials to wipe the screen.</p>
	Poor USB connection.	<ul style="list-style-type: none"> <li>• Check if the USB cable has been connected properly, or try with another USB cable.</li> <li>• Connect the computer with your display only; remove other USB peripherals.</li> <li>• Connect a computer with the display through USB cable directly without any extension (e.g. faceplate or USB extension cable) to ensure the touch function works.</li> </ul>

 The drawing is not displayed correctly (e.g., double lines, spiking, etc.).

	Possible causes	Possible solutions
	An inappropriate stylus (particularly too thin) is used.	Try with a thicker stylus. Refer to the following stylus specifications.



Touch vendor	Stylus dimensions	Accuracy	Applicable models
NextWindow	< 47" diameter: Ø6, 65": Ø9	± 3mm ≤ 55" 5mm > 55"	T420/T650/TL550/TL650/ RP650/RP650+
Nexio	42"/45"/55": Ø8	± 2.5mm	IL420/IL460
IRTouch	65" diameter: Ø8	± 1.5mm in center, ± 2.5mm near border	IL650/RM650
CVTTouch	6mm for single touch 8mm for multi touch	+/-2.0mm (Over 90% of touchable area)	RP551/RP651/RP700/RP701/ RP552/RP652/RP702/RP705/ RP790/RP840G/RP553K/ RP653K/RP654K/RP704K/ RP750K/RP860K/RP860S/ IL430/IL490/IL550
IST U	3mm for single touch 6mm for multi touch	+/-1.0mm (over 90% of touchable area)	RM5501K/RM6501K/ RM7501K/RM8601K
IST X	2mm for single touch 5mm for multi touch	+/-1.0mm (over 90% of touchable area)	RP6501K/RP7501K/RP8601/ RM5502K/RM6502K/ RM7502K/RM8602K
CVTE P-Cap	6mm for passive 2mm for active	+/- 1.5mm (over 90% of touchable area)	CP6501K/CP8601K
IRTouch HE series	>2mm	+/- 1mm (over 90% of touchable area)	RP6502, RP7502, RP8602
IRTouch MD series	>3mm	+/- 1mm (over 90% of touchable area)	RE6502, RE7502, RE8602
IST F series	>3mm	+/- 2mm (90% active area located in middle)	RM6052S, RM7502S, RM8602S
Annax P-cap	>8mm	+/- 3mm	BH2401T, BH3501T
IRTouch HE-6 series	>2mm	+/- 1mm (90% active area located in middle)	RM6503, RM7503, RM8603
KTC T50 series	>2mm	+/- 1mm (90% active area located in middle)	IL4301, IL5501

Strong light reflection.	Re-direct the lights or move the display to another location to avoid unwanted reflections from light sources.
The interactive software (purchased and installed separately by user) may not be compatible with the system.	<ul style="list-style-type: none"> <li>• Try with a different version of interactive software.</li> <li>• Try with the basic drawing program pre-installed on your computer. (e.g. Microsoft Paint in Windows).</li> </ul>
Poor USB connection.	Check if the USB cable has been connected properly, or try with another USB cable.



## OSD menu/control panel/power button



? The OSD menu does not work.



✓ Possible causes	Possible solutions
The control panel (keypad) could be damaged.	Contact the BenQ authorized service partner for replacement.

? The keypad or IR (remote control) does not work.

✓ The keypad or IR could be locked. Please check the following to unlock it.

Model/Function	Keypad Lock/unlock	IR (remote control) lock/unlock	Lock/unlock keypad and touch	Remark
RP654K, RP704K, RP750K, RP860K	<ol style="list-style-type: none"> <li>Press green button on the remote control.</li> <li>OSD setting</li> </ol>	OSD setting	Press red button on the remote control.	<ol style="list-style-type: none"> <li>The Key Lock and IR Lock functions cannot be enabled at the same time.</li> <li>Lock/unlock touch - yellow button on remote control.</li> </ol>
RP552, RP552H, RP653, RP703, RP840G	OSD setting	OSD setting	Press red button on the remote control.	
RP553K, RP653K, ST430K, ST550K, ST650K, RM5501K, RM6501K, RM7501K, RM8601K	<ol style="list-style-type: none"> <li>Press and hold [CH+] button.</li> <li>OSD setting</li> </ol>	<ol style="list-style-type: none"> <li>Press and hold [CH+] button.</li> <li>OSD setting</li> </ol>		
IL430, IL490, IL550, SL490, SL550	<ol style="list-style-type: none"> <li>Press both + and  of remote control buttons and hold for more than 3 seconds.</li> <li>OSD setting</li> </ol>	<ol style="list-style-type: none"> <li>Lock - OSD setting</li> <li>Unlock - press and hold [i]INFO button on the remote control for 6 seconds.</li> </ol>		
PL490, PL552, PL553, PH5501, PH5502	<ol style="list-style-type: none"> <li>Press  and 1998 on the remote control.</li> <li>OSD setting</li> </ol>	<ol style="list-style-type: none"> <li>Press  and 1998 on the remote control.</li> <li>OSD setting</li> </ol>		

ST4301K, ST5501K, ST6501K	OSD setting	OSD setting		Key lock and IR lock functions cannot be enabled at the same time.
RP6501K, RP7501K, RP8601K	OSD setting	OSD setting	<p>Unlock only:</p> <ol style="list-style-type: none"> <li>1. MENU [V+] [V+] [V-] (before FW v1.0.0.8)</li> <li>2. Press  on the remote control for five seconds (after FW v1.0.0.8).</li> </ol>	Lock/unlock touch - OSD setting
RM5502K, RM6502K, RM7502K, RM8602K, CP6501K, CP8601K, RM6502S, RM7502S, RM8602S, RM6503, RM7503, RM8603	OSD setting	OSD setting	<p>Unlock only:</p> <p>Press  on the remote control for five seconds.</p>	Lock/unlock touch - OSD setting
SL4302K, SL5502K, SL6502K, SL7502K, SL8602K, SL9802K	OSD setting	OSD setting		Key lock and IR lock functions can be enabled at the same time.

BH2401, BH2401T, BH3501, BH3501T, BH2801, BH2801N, BH3801, BH3801N, BH3801D, ST4302, ST5502, ST6502, ST7502, ST8602	1. OSD setting 2. Vol+ up left down right	1. OSD setting 2. Vol+ up left down right		
RE6501, RE7501, RE8601, RP6502, RP7502, RP8602, IL4301, IL5501	OSD setting	OSD setting	1. Press  on the remote control for five seconds. 2. Press  on the keypad for five seconds.	Lock/unlock touch - OSD setting

 Some of the OSD menu options are grayed out. When are those items available for setup?

 Available menu options may vary depending on the input sources, functions and settings.

 The power button does not respond.



Possible causes	Possible solutions
Power cord is not connected properly.	Re-connect the power cord.
The control panel could be damaged.	Contact the BenQ authorized service partner for replacement.

## LED indicators

 The LED indicator of control panel (keypad) or IR receiver flashes red quickly.



Possible causes	Possible solutions
The main board could be damaged.	Contact the BenQ authorized service partner for replacement.

## Power

 The display can't be powered on.

Possible causes	Possible solutions
-----------------	--------------------



No power is supplied to the display.	<ul style="list-style-type: none"><li>• Re-connect the power cord.</li><li>• Check if the power outlet works.</li></ul>
One of the key components of the display could be damaged.	Contact the BenQ authorized service partner for replacement.

## System: PL460/PH460/PL550/PH550

-  How to restore the factory default settings?



 Go to **Setting > All Reset**. All except the settings under the **Picture** and **Sound** menus will be restored back to the factory default settings.



To reset all settings in **Picture**, go to **Picture > Reset**.



To reset all settings in **Sound**, go to **Sound > Reset**.
  
-  How to set time and date?

 Go to **Setting > Schedule**.

Press the control panel buttons to adjust the system clock. Refer to the user manual for more information.
  
-  What to do if the **Out of Range** message is prompted?

 The resolution currently set is not supported. Refer to **Supported input signal resolution** in the user manual of the purchased model for the supported timings.
  
-  What are the supported resolutions of my display?

 The supported resolutions may differ by model. Refer to **Supported input signal resolution** in the user manual of the purchased model for details.
  
-  Vapor or mist is observed inside the glass.

 Under certain circumstances, condensation may occur on the inner side of the cover glass, it's a natural phenomenon and will not affect the operation of the display. This condensation will usually disappear after around 2 hours of normal operation.
  
-  How to check the version of system software?

 Go to **Setting > Information > Software Version** to find out the software version.

## Troubleshooting: PL490/PL552/PL553/PH550I/PH5502

Symptom	Possible Cause	Remedy
No picture is displayed.	<ol style="list-style-type: none"> <li>1. The power cord is disconnected.</li> <li>2. The main power switch on the back of the display is not switched on.</li> <li>3. The selected input has no connection.</li> <li>4. The display is in standby mode.</li> </ol>	<ol style="list-style-type: none"> <li>1. Plug in the power cord.</li> <li>2. Make sure the power switch is switched on.</li> <li>3. Connect a signal connection to the display.</li> </ol>
Interference displayed on the display or audible noise is heard.	Caused by surrounding electrical appliances or fluorescent lights.	Move the display to another location to see if the interference is reduced.
Color is abnormal.	The signal cable is not connected properly.	Make sure that the signal cable is attached firmly to the back of the display.
Picture is distorted with abnormal patterns.	<ol style="list-style-type: none"> <li>1. The signal cable is not connected properly.</li> <li>2. The input signal is beyond the capabilities of the display.</li> </ol>	<ol style="list-style-type: none"> <li>1. Make sure that the signal cable is attached firmly.</li> <li>2. Check the video signal source to see if it is beyond the range of the display. Please verify its specifications with this display's specification section.</li> </ol>
Display image doesn't fill up the full size of the screen.	<ol style="list-style-type: none"> <li>1. The zoom mode is not set correctly.</li> <li>2. Scan Mode may be set incorrectly to underscan.</li> <li>3. If the image exceeds the screen size, Scan Mode may need to be set to Underscan.</li> </ol>	Use the Zoom mode or Custom zoom function in the Screen menu to fine tune display geometry and time frequency parameter.
Can hear sound, but no picture.	Improperly connected source signal cable.	Make sure that both video inputs and sound inputs are correctly connected.
Can see picture but no sound is heard.	<ol style="list-style-type: none"> <li>1. Improperly connected source signal cable.</li> <li>2. Volume is turned all the way down.</li> <li>3. <b>Mute</b> is turned on.</li> <li>4. No external speaker connected.</li> </ol>	<ol style="list-style-type: none"> <li>1. Make sure that both video inputs and sound inputs are correctly connected.</li> <li>2. Press <b>+</b> or <b>-</b> button to hear sound.</li> <li>3. Switch MUTE off by using  the button.</li> <li>4. Connect external speakers and adjust the volume to a suitable level.</li> </ol>



Symptom	Possible Cause	Remedy
Some picture elements do not light up.	Some pixels of the display may not turn on.	This display is manufactured using an extremely high level of precision technology; however, sometimes some pixels of the display may not display. This is not a malfunction.
After-Images can still be seen on the display after the display is powered off. (Examples of still pictures include logos, video games, computer images, and images displayed in 4:3 normal mode)	A still picture is displayed for an over extended period of time.	Do not allow a still image to be displayed for an extended period of time as this can cause a permanent after-image to remain on the display.

## Wall mounting/video wall

? Is wall mounting kit available?

✓ The wall mounting kit should be purchased separately, though the screws needed for wall mounting are included in the product.

✎ The mounting interface should comply with the ULI678 standard in North America. The mounting means should be strong enough to bear the weight of the display.

? What to do if colors among all displays do not match?

✓ Re-connect a cable from one computer to another to check if it is the video output that went wrong.

Re-connect a cable from one display to another to check if it is the display that went wrong.

If it is the video input that went wrong, check the following:

- Make sure that the signal is output from the same source (e.g. D-Sub).
- It is recommended to use cables of equal length for connection.
- Do not use more than 2 splitters to produce video wall.
- If the total fitment width of the video wall is more than 10 meters, use an amplifier or resistance wire avoid signal attenuation during transmission.
- If the signal came from more than one computer, make sure that all computers use the same type of graphic card.

If it is the display that went wrong, check the following:

- Check if all the settings of the following options in the **Picture** menu on all displays are identical.
  - **Picture Mode** (**Standard** mode is recommended)
  - **Backlight**
  - **Contrast**
  - **Brightness**
  - **Chroma**
  - **Phase**
  - **Sharpness**
  - **Color Temp.**
- Check if the settings of **Adaptive Contrast** and **Ambient Light Sensor** in **Setting > Advanced** on all displays are identical.
- Adjust the colors by calibration tools (purchased separately).

I, \_\_\_\_\_ hereby confirm that I have read this document and understand its content.

## Preventing afterimage burn-in

If you leave the screen fixed on a stationary image for an extended period of time, afterimage burn-in or defective pixels may occur. Power-saving mode or a dynamic screen saver should be activated in case you will not be using the product for an extended period of time.

When the LCD panel is not operating normally, afterimage burn-in may occur.

Normal operation means a consecutively changing video pattern. If the LCD panel shows a fixed pattern for an extended period of time, a little voltage difference may occur between the electrodes in pixels controlling the liquid crystals.

The voltage difference between electrodes may increase with time. This can cause the liquid crystals to get thinner. A previous image can stay on the screen as the pattern changes. To avoid this situation, the compiled voltage difference should be diminished.

To avoid afterimage burn-in, turn off the power or set the PC or system to run a screen saver when not in use. Warranty service may be restricted relying on the instruction guide.

### Power saving mode

- After using the product for 12 hours, turn it off for 2 hours.
- Power saving mode may vary by models. Please refer to user manuals for more information.
- Use a recommended screen saver. A single-color or moving-image screen saver is the best.

### Regular color change

- Switch between 2 colors every 30 minutes.
- Avoid mixing a text color and background color of contrasting brightness.
- Prevent using grey as it may cause afterimage burn-in.
- Prevent using colors of contrasting brightness, e.g., black and white.

### Regular text color change

Use bright colors of similar brightness and regularly show a moving image along with a logo.



- Change text color and background color every 30 minutes.
  - Show a moving image along with a logo for 60 seconds after using for 4 hours.
-

# Appendix I: Installation Checklists

Check the following one by one for a new installation. Contact the BenQ local customer service center with the checking results if any severe damages is found before a new installation.

## Before installation

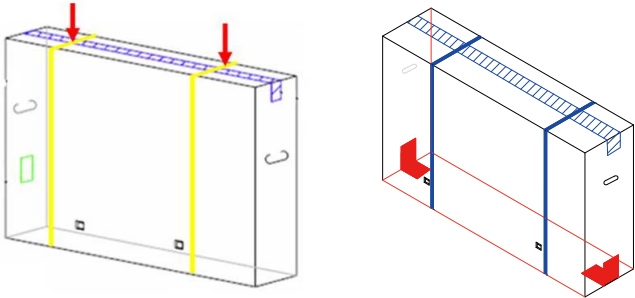
No.	Check items	Checking results		Location & description of problem
		Yes	No	
1.	The Installation Handbook has been read through carefully.			
2.	<ul style="list-style-type: none"> <li>For certain models, there may be void labels or additional packing tapes on the carton. Check whether the labels or tapes are broken. If broken, take the photos and contact BenQ for further assistance.</li> <li>If the unit is packed in the pallet, please identify where the unit is placed in the pallet.</li> </ul> 			
3.	Check if the shock indicator (if available) on the carton has changed its color from white to red.			
4.	Check if there is any serious damage to the carton, especially to the edges and surface area.			
5.	Check if there is any serious scratches, marks or damages caused by collision to the inner side of the carton.			
6.	Check if the cushions or PE bags are broken or distorted.			
7.	Check if there is any serious damage (i.e. scratches, cracks, bends) to the bezel, metal frame, rear cover, and the accessories			
8.	Check if any accessory is missing.			
9.	Check if the panel is damaged (i.e. scratched or cracked).			
10.	Power on the display and check if the screen is normal.			

## After installation

No.	Check items	Checking results		Location & description of problem
		Yes	No	
1.	Check if there is any damage to the panel (scratches or cracks) or to the bezel (scratched or faded paint).			
2.	Check if all cables have been connected properly.			
3.	(For video wall) Check if all displays have been installed on a (horizontal/vertical) level surface.			
4.	(For video wall) Check if there is enough space (0.5 mm as recommended) between two displays.			
5.	Connect your video source (e.g. computer) and power on the display to check if the screen is normal.			

## Warranty information

BenQ warranty does not cover the damages caused by improper installation, operation, or storage of the product, including but not limited to the following:

1. Damages to the packaging or product after re-packing. This includes but not limited to the color change of shock indicator (if available), serious scratches on the package, and/or broken cushions or PE bags. Please make sure to check the product and all the supplied items once the original package is unsealed.
2. Panel bending and/or distorted corner(s) of panel caused by improper installation or storage, or inappropriate way to move the display.
3. Scratches, cracks, faded paint, and/or other physical damages to the panel, bezel, metal frame, rear cover, and accessories.
4. Abnormal display (lines, mura, or light leakage) caused by the collision or excessive force during installation.
5. Missing accessories during installation.
6. Any damages or performance failure caused by not following the instructions in the Installation Handbook.
7. LCD screens, like plasma (PDP) and conventional CRT (Cathode Ray Tube) screens, are also susceptible to 'screen burn-in' or 'image retention' which can be found on the screen as visible fixed lines and shades. To avoid such damage to the screen, avoid displaying still images (like On-Screen Display menus, TV station logos, fixed/inactive text or icons) for more than two hours. Change the aspect ratio from time to time. Fill the entire screen with the image and eliminate the black bars whenever possible. Avoid displaying images in 4:3 aspect ratio over a long period of time, otherwise there may be visible burn marks on the screen as two vertical lines.



- It is the sole responsibility of the user if problems (e.g. system failure) occurred due to non-factory installed parts and/or non-original accessories.
  - Under certain circumstances, condensation may occur on the inner side of the cover glass, it's a natural phenomenon and will not affect the operation of the display. This condensation will usually disappear after around 30 minutes of normal operation.
- 

I, \_\_\_\_\_ hereby confirm that I have read this document and checked the items mentioned above.

## Appendix 2: Basic Troubleshooting Checklists for IFP & IL series

Dear Customer,

In order to avoid unnecessary delays and a volley of questions back and forth may we ask, kindly fill in the form below. The more comprehensive information we have the faster our response will be.

### Part I: customer feedback form (customer information and description of problem)

Onsite contact person:	
Phone number:	
E-mail address:	
Address of unit:	

Model name:	
-------------	--

Quantity on site:	_____ unit(s).
-------------------	----------------

Quantity affected:	_____ unit(s).
--------------------	----------------

Problem frequency:	Constantly	Intermittently	After a while

Problem type:	Touch	Power	Display	Android/APP	Other
Short problem description					

Connections visible:	HDMI (Figure 1)	D-Sub (VGA) (Figure 2)	USB (Figure 3)	DVI (Figure 4)	DisplayPort (Figure 5)

Question	Yes	No	Not certain
Are the affected units connected to a faceplate (Figure 6)?			
Are the cables passing through any wall or floor trunking?			
Is the original USB cable (Figure 3) provided by BenQ being used?			

Question	Yes	No	Not certain
Are there any extensions being used with the USB cable (Figure 3)?			
Are there any USB-powered hubs (Figure 7) being used?			
Are there any USB-CAT5 converters (Figure 8) being used?			
Do you know what version of Smart Notebook Software (if provided) is installed in your computer?			
Please specify your computer operating system and version.			
What is the main device (video source) connected to the display? Please specify the brand and the model name.	Desktop	Laptop	Other
(Skip this question if no laptop is being used.) If the video source is a laptop, is it plugged into a powered wall socket?			
What is the USB cable (Figure 3) length, including trunking in wall?	_____ meters.		
What is the signal cable (HDMI, DVI, VGA, etc.) length, including trunking in wall?	_____ meters.		
Who installed these units for you?			
Please provide the installer's contact name & phone number.			
Are there any non-BenQ preloaded APP?			
Please specify the name of APP which having the issue.			

Additional information
Provide photo/video link



## Part II: problem resolving attempt & troubleshooting

The following checklist helps you identify the problem and resolve it quickly. In case a specific problem occurs, refer to its related section and follow the check items to resolve the problem. Contact the service provider if the problem cannot be resolved as instructed in this checklist.

Possible problems are:

- Power
- Ghost touch
- Failed calibration
- Compatibility - Cannot detect IFP/DS
- Touchscreen
- Flickering picture
- Add extender/repeater
- Android/APPs
- Intermittent touch signal loss
- Condensation
- Noise/interference
- OTA

### Power

Try the following if the display cannot be powered up.

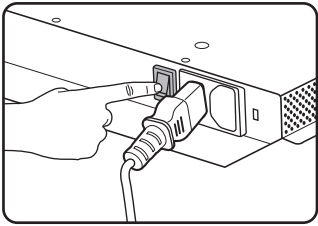
Check item	Check if completed	Does the problem still exist?	
		Yes	No
Please try replace the power cord.			
Check if the power cable has been properly connected.			
Please try to connect the display to a different power outlet.			
Make sure the power switch (usually located at the rear of the display) is switched on. 			
Check the status of the power indicator – what color is it?			

### Touchscreen

Check item	Check if completed	Does the problem still exist?	
		Yes	No
Please try with another USB cable ( <a href="#">Figure 3</a> ).			

Check item	Check if completed	Does the problem still exist?	
		Yes	No
Please try with another USB port on the video source (e.g. computer).			
Please try to connect the display to another video source (e.g. computer).			
Please try to connect the display to the video source (e.g. computer) directly without any extension/trunking/faceplate.			
Try to un-install the Smart Notebook software (if provided), and install an earlier version. Contact the service provider for an earlier version if needed.			
Try with Windows Paint (for Windows operating systems).			
Try with a thicker touch pen (6 mm as recommended, <a href="#">Figure 9</a> ) for drawing on the touchscreen.			
Use USB cable shorter than 5m or use extender if longer than 5m.			
If the touch is not working only under Android, please connect to the external device to confirm.			

### Intermittent touch signal loss

Check item	Check if completed	Does the problem still exist?	
		Yes	No
Please try with a different video source (e.g. computer).			
Please try with a shorter USB cable ( <a href="#">Figure 3</a> ).			
Please try with another USB port on the video source (e.g. computer).			
Please try use a USB-powered hub ( <a href="#">Figure 7</a> ) to connect the video source (e.g. computer) and your display.			
Use USB cable shorter than 5m or use extender if longer than 5m.			

## Ghost touch

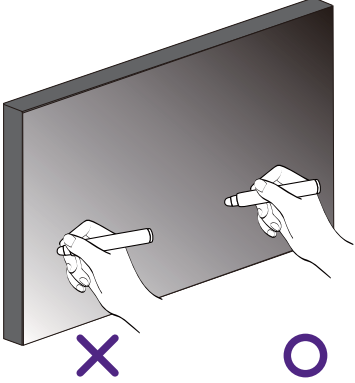
Check item	Check if completed	Does the problem still exist?	
		Yes	No
Moisten a clean, soft, lint-free cloth with a neutral detergent and then clean the frame and the touchscreen carefully.			
Please try to draw the lines in Windows Paint (for Windows operating systems).			
Make sure that only the tip of the touch pen touches the screen.			
<p>Keep your hand away from the touchscreen, as the detectors may detect your hand even it does not touch the screen surface.</p> 			

## Flickering picture

Check item	Check if completed	Does the problem still exist?	
		Yes	No
Please try with another video signal cable (HDMI/D-Sub/DVI/DP).			
Please try with another video input. For example, change from D-Sub to HDMI or DVI.			
Please try with another video source. For example, change a computer.			
Check if all cables are connected properly.			
Un-plug the USB cable (if connected, <a href="#">Figure 3</a> ).			
Please try with a D-Sub cable with a thicker EMI core (ferrite filter, <a href="#">Figure 10</a> ), which suppresses more high frequency noise.			
Please try to connect the display to a different power outlet.			

Check item	Check if completed	Does the problem still exist?	
		Yes	No
Check the timing using is supported by the device.			

## Condensation

Condensation on the inner side of the glass is a natural phenomenon when the temperature and humidity of the air change quickly. Condensation may occur if the display is powered on after not being used for a long time, or if the heating system of the room is switched on. And it may last for hours.

Check item	Check if completed	Does the problem still exist?	
		Yes	No
Keep the display powered on for at least 24 hours.			
Keep the display away from the window.			

## Failed calibration

Check item	Check if completed	Does the problem still exist?	
		Yes	No
Please try with the built-in calibration tool on the Windows operating system.			
Contact the service provider to see if a calibration software is available.			

## Add extender/repeater

Check item	Check if completed	Does the problem still exist?	
		Yes	No
If the touch is not working, please add a USB hub/extender.			
If there is no display, please add the display port repeater (ex.HDMI repeater).			

Check item	Check if completed	Does the problem still exist?	
		Yes	No
Try with shorter cables (shorter than 3M for display cable/1.8M for touch USB cable). If the problem is solved, please try to add the repeater.			

### Noise/interference

Check item	Check if completed	Does the problem still exist?	
		Yes	No
Unplug the USB cable.			
If unplugging the USB cable can solve the problem, please use the digital signal (ex. HDMI or DVI) with the touch USB cable.			
Try to use another AC socket.			
Try to use the AC jack without ground.			

### Compatibility - Cannot detect IFP/DS

Check item	Check if completed	Does the problem still exist?	
		Yes	No
Try another PC/NB (different brand/model).			
Try to add the repeater to boost the signal.			

### Android/APPs













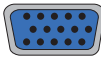

Check item	Check if completed	Does the problem still exist?	
		Yes	No
Uninstall any other non-BenQ authorized/preloaded APPs.			
Clear the APP data (setting>Application>clear data).			
Restore the setting under Android Setting.			

# OTA

Check item	Check if completed	Does the problem still exist?	
		Yes	No
Make sure the internet connection is extranet.			
Try another internet connection (ex. Use hotspot from mobile).			

## Pictures for reference

The following pictures are for your reference only. The cables or connectors may be different depending on the products available in your country/region.

  <p>Figure 1 HDMI cable</p>	  <p>Figure 2 D-Sub (VGA) cable</p>	  <p>Figure 3 USB cable</p>	  <p>Figure 4 DVI cable</p>
  <p>Figure 5 DisplayPort cable</p>	 <p>Figure 6 Wall Faceplate (with USB type-A port)</p>	 <p>Figure 7 USB-powered hub (Must be powered by an adaptor and plugged into a wall socket.)</p>	 <p>Figure 8 USB-CAT5 converter</p>
 <p>Figure 9 Touch pen</p>	 <p>Figure 10 VGA cable with thicker EMI core</p>		

## Appendix 3: Basic Troubleshooting Checklists for Video Wall

Dear Customer,

In order to avoid unnecessary delays and a volley of questions back and forth may we ask, kindly fill in the form below. The more comprehensive information we have the faster our response will be.

### Part I: customer feedback form (customer information and description of problem)

Onsite contact person:	
Phone number:	
E-mail address:	
Address of unit:	

Model name:	
Serial number:	
Scalar FW version:	
LAN FW version:	

Quantity on site:	_____ unit(s). H _____ units V _____ units
Quantity affected:	_____ unit(s).

Usage time:	_____ months/days/hours
-------------	-------------------------

Problem frequency:	Constantly	Intermittently	After a while

Problem type:	Picture	Power	Uniformity (color, etc.)	External device(s)	Other
Short problem description					

Connections:	HDMI	D-Sub (VGA)	DVI	Display Port	Others

Daisy Chain:	HDMI	D-Sub	DVI	IR	RS232	Display Port	No daisy chain

Question	Yes	No	Not certain
Are the affected units connected to a faceplate?			
Are the cables passing through any wall or floor trunking?			
Is the original cable provided by BenQ being used?			
Are the affected units connected through splitter, matrix or other video wall controller?			
Please specify your computer operating system and version.			
What is the main device (video source) connected to the display? Please specify the brand and the model name.	Desktop	Laptop	Other
What is the signal cable (HDMI, DVI, VGA, etc.) length, including trunking in wall?	_____ meters.		
Please provide the installer's contact name & phone number.			

Additional information
Provide photo/video link



## Part II: problem resolving attempt & troubleshooting

The following checklist helps you identify the problem and resolve it quickly. In case a specific problem occurs, refer to its related section and follow the check items to resolve the problem. Contact the service provider if the problem cannot be resolved as instructed in this checklist.

Possible problems are:

- [Power](#)
- [Pictures](#)
- [Video Wall](#)
- [Color Management](#)
- [Compatibility](#)

### Power

Try the following if the display cannot be powered up.

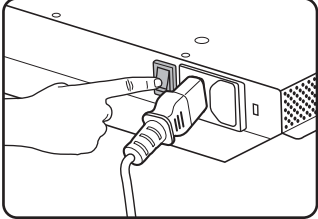
Check item	Check if completed	Does the problem still exist?	
		Yes	No
Please try replace the power cord.			
Check if the power cable has been properly connected.			
Please try to connect the display to a different power outlet.			
Please confirm that the power supply is enough to support the power for all displays.			
Make sure the power switch (usually located at the rear of the display) is switched on.  			

### Video Wall

Check item	Check if completed	Does the problem still exist?	
		Yes	No
Please use the line-interactive RS232 cable (if applicable).			
Please upgrade the firmware if it is not the latest version.			
Please check if all cables are working properly.			

Check item	Check if completed	Does the problem still exist?	
		Yes	No
Please check if the settings in the OSD are the same for all displays.			
Please confirm the total units are not exceeded the suggested daisy chain Q'ty: VGA: Suggested 4 units; Max. 9 units DVI/HDMI/Display Port: Suggested 12 units; Max. 16 units			
Try to connect to our display directly if splitter/matrix/video wall controller is used.			

## Compatibility

Check item	Check if completed	Does the problem still exist?	
		Yes	No
Please change another signal cable and check if this problem is related to signal cable (better quality & shielding cable is recommended).			
Please connect the Pattern generator (PC/Notebook/media player) and display <u>at the same power source</u> , and make sure the power cable has ground pin to avoid the noise interference.			
Please connect the Pattern generator (PC/Notebook/media player) and display <u>at different power source</u> , and make sure the power cable has ground pin to avoid the noise interference.			
Check if the display name could be shown. If it is not shown, please press detect button again.			
			
Please make sure the graphic card driver is the latest version.			

Check item	Check if completed	Does the problem still exist?	
		Yes	No
Please use the suggested resolution (1920x1080).			
Please try with another input source (laptops, desktops...etc).			

## Pictures

Check item	Check if completed	Does the problem still exist?	
		Yes	No
Use the Windows desktop with full screen picture (could not be black screen), and select the auto-adjustment again. Check if the picture could show correctly after auto adjustment.			
If using VGA signal, please adjust the screen under OSD setting, and check if the picture could be adjusted as normal picture.			
Please check the resolution setting of graphic card, and see if the setting is extended to full screen with 1080p output.			
Check if the Picture Settings in the OSD menu are the same.			
If the problem could not be solved by the above actions, please record the resolution setting/graphic card information/driver version/detected resolution by display and take a picture for abnormal picture.			

## Color Management

Check item	Check if completed	Does the problem still exist?	
		Yes	No
Please confirm the input source (VGA or HDMI or DVI or Display Port).			
The value should be default for R/G/B Gain and Offset.			
If the color does not match after installing the video wall, please adjust the R/G/B value manually. If it does improve, please check the quality of the cables.			
Please use X-Rite Sensor to measure the center of the calibration unit and confirm if the abnormal unit is in spec or not (Color temperature deviation over +/- 0.5% & brightness over 15 nits).			

Check item	Check if completed	Does the problem still exist?	
		Yes	No
Make sure that you had warmed up the unit over an hour before starting the color calibration.			

## Appendix 4: Basic Troubleshooting Checklists for X-Sign

Dear Customer,

In order to avoid unnecessary delays and a volley of questions back and forth may we ask, kindly fill in the form below. The more comprehensive information we have the faster our response will be.

### Part I: customer feedback form (customer information and description of problem)

Onsite contact person:	
Phone number:	
E-mail address:	
Address of unit:	

Model name:	
-------------	--

Quantity on site:	_____ unit(s).
-------------------	----------------

Quantity affected:	_____ unit(s).
--------------------	----------------

Unit F/W version:	
X-Sign player version:	
X-Sign designer version:	

Problem frequency:	Constantly	Intermittently	After a while

Problem type:	Installation	Connection	Content display	Scheduling	Other
Short problem description					

Connections visible:	HDMI	USB			

Question	Yes	No	Not certain
Are the affected units connected to a network?			
Are the cables passing through any wall or floor trunking?			
Please specify your computer operating system and version.			
What is the main device (video source) connected to the display? Please specify the brand and the model name.	Desktop	Laptop	Other
(Skip this question if no laptop is being used.) If the video source is a laptop, is it plugged into a powered wall socket?			
Who installed these units for you?			

Additional information
Provide photo/video link

## Part II: problem resolving attempt & troubleshooting

The following checklist helps you identify the problem and resolve it quickly. In case a specific problem occurs, refer to its related section and follow the check items to resolve the problem. Contact the service provider if the problem cannot be resolved as instructed in this checklist.

Possible problems are:

- [Installation/update](#)
- [Content display](#)
- [Others](#)
- [Touchscreen \(if device support\)](#)
- [Scheduling](#)
- [Network Connection](#)
- [Content design](#)

### Installation/update

Try the following if X-Sign Designer cannot be installed on a laptop or if X-Sign Player is unable to update on a digital signage.

Check item	Check if completed	Does the problem still exist?	
		Yes	No
[Designer] Please check if Windows version is 64 bit (not support 32bit).			
[Player] Please check if the network port & DNS is blocked by ITS (check by PortTester). <ul style="list-style-type: none"> <li>• Port No. should be 443.</li> <li>• Cloud server should be:  <a href="https://Relay.benq.com">https://Relay.benq.com</a>  <a href="https://Apiservice.benq.com">https://Apiservice.benq.com</a>  <a href="https://X-Sign.benq.com">https://X-Sign.benq.com</a> </li> </ul>			
[Player] Please launch browser to check the WAN status if the dialog shows “No internet connection” or “update failed”.			
[Cannot pair device] Please check if the available (not expired) license is existed on the license list.			
If problems cannot be solved after performing the above actions, please re-flash the system firmware.			

## Touchscreen (if device support)

Check item	Check if completed	Does the problem still exist?	
		Yes	No
[Cannot touch icon] Check if the interactive content tier is up to 2+ layer.			
If problems cannot be solved after performing the above actions, please re-flash the system firmware.			

## Network Connection

Check item	Check if completed	Does the problem still exist?	
		Yes	No
Please check WAN connection if X-Sign player shows “Internet connection available”. <ul style="list-style-type: none"> <li>• Port No. should be 443.</li> <li>• Cloud server should be:  <a href="https://Relay.benq.com">https://Relay.benq.com</a>  <a href="https://Apiservice.benq.com">https://Apiservice.benq.com</a>  <a href="https://X-Sign.benq.com">https://X-Sign.benq.com</a> </li> </ul>			
Please check if the port & DNS is blocked by ITS. <ul style="list-style-type: none"> <li>• Port No. should be 443.</li> <li>• Cloud server should be:  <a href="https://Relay.benq.com">https://Relay.benq.com</a>  <a href="https://Apiservice.benq.com">https://Apiservice.benq.com</a>  <a href="https://X-Sign.benq.com">https://X-Sign.benq.com</a> </li> </ul>			
If problems cannot be solved after performing the above actions, please re-flash the system firmware.			

## Content display

Check item	Check if completed	Does the problem still exist?	
		Yes	No
[Webview] If a webpage cannot show correctly (ex. animation, picture...etc), please use the embedded browser in the display and check if it can show correctly.			

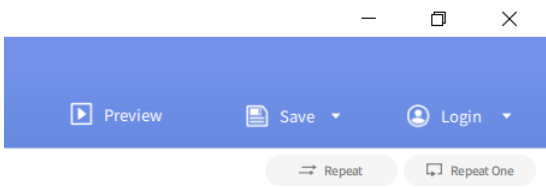

Check item	Check if completed	Does the problem still exist?	
		Yes	No
[Content display abnormal] Please try to use another video/picture format and upload it again.			
[Cannot play after inserting a USB flash drive in standalone mode] Please check if X-Sign mode on player is changed to “Standalone Mode”.			
[Cannot play after inserting a USB flash drive in standalone mode] Please check the file name and file path.			
[Content cannot displayed] Please launch a template on X-Sign Designer, and check if the play mode “Repeat” is on. 			
If problems cannot be solved after performing the above actions, please re-flash the system firmware.			

## Scheduling

Check item	Check if completed	Does the problem still exist?	
		Yes	No
[Content not showing] If the screen shows X-Sign wall paper, please check if the content schedule is on-time or not.			
[Content not showing] Please check if the storage size is larger than content type.			
[Stop playing in scheduling] Check if the schedule is “every date” or “specific date”.			
If problems cannot be solved after performing the above actions, please re-flash the system firmware.			

## Content design

Check item	Check if completed	Does the problem still exist?	
		Yes	No
[Local delivery-device cannot be scanned] Please check if the port & DNS is blocked by ITS.			
[Cannot upload files to Manager] Please check if you have logged in to Manager by registering an account in Designer.			
[Cannot add video content] Please check if the video file size is less than 1.5 GB.			
[Cannot add image content] Please check if the video file size is less than 100 MB.			
[Cannot add video content] Please check if the video object is fewer than two.			
If problems cannot be solved after performing the above actions, please re-flash the system firmware.			

## Others

Check item	Check if completed	Does the problem still exist?	
		Yes	No
[Device shown online but unable to upload/deliver content] Please try to reboot device and check again.			
[Real time message not shown] It may be caused by network delay, so please wait for a while.			
If problems cannot be solved after performing the above actions, please re-flash the system firmware.			

## Additional for X-Sign Broadcast

Check item	Check if completed	Does the problem still exist?	
		Yes	No
[Unable to broadcast] Make sure the time zone of the unit and Manager are the same (enable auto time sync).			
[Unable to broadcast] Make sure the external network can be connected.			