



Multiple Display Administrator User Manual



Disclaimer

BenQ Corporation makes no representations or warranties, either expressed or implied, with respect to the contents of this document. BenQ Corporation reserves the right to revise this publication and to make changes from time to time in the contents thereof without obligation to notify any person of such revision or changes.

Copyright

Copyright 2016 BenQ Corporation. All rights reserved. No part of this publication may be reproduced, transmitted, transcribed, stored in a retrieval system or translated into any language or computer language, in any form or by any means, electronic, mechanical, magnetic, optical, chemical, manual or otherwise, without the prior written permission of BenQ Corporation.

Table of Contents

Disclaimer	2
Copyright.....	2
Introduction	5
System requirements	5
Initial Setup	6
Installing Multiple Display Administrator.....	6
Connecting display(s) to the computer	6
RJ-45 Ethernet connection	6
RS-232C connection.....	7
Launching Multiple Display Administrator	7
Overview of components and functions.....	8
Toolbar.....	8
Monitor list panel.....	9
Control panel.....	9
Managing displays	10
Searching for displays.....	10
Serial (RS-232C) connection.....	10
Ethernet (LAN) connection	11
Managing displays on the Monitor list panel.....	11
Tagging a display.....	11
Creating a group.....	12
Deleting a group	12
Adding displays to an existing group.....	13
Deleting a display from a group	14
Deleting a display from the Monitor list panel	14
Setting display ID automatically.....	14
Saving and loading display configuration files.....	14
Setting up display configurations	15
Information tab.....	15

Control tab.....	18
AV tab	19
Schedule tab	20
Display Wall tab.....	21
Creating a display wall	21
Modifying display wall settings.....	25
Alarm tab.....	27
Additional operations.....	28
Changing login ID and password	28
Changing language	28
Troubleshooting	29

Introduction

The Multiple Display Administrator is a software program that enables remote and centralized management of a single or multiple BenQ digital signage displays on a host computer. You can create and edit display groups, view status of displays as well as change display settings. You can also tile multiple displays and create a video wall easily through a step-by-step guided wizard.

The key features of the Multiple Display Administrator include:

- Automatic search for displays on the same Ethernet or RS-232C network
- Easy and intuitive management of displays and display groups
- Remote access to display settings and operations including power on/off and input source selection
- Real-time monitoring of display status
- Step-by-step guided video wall setup

System requirements

To install and run Multiple Display Administrator, the computer must meet the following minimum hardware and software requirements.

CPU	Pentium/Athlon 1.8GHz
Free memory	512 MB
Hard disk space	100 MB
Connectivity	An available Ethernet RJ-45 port (for Ethernet connection) or RS-232C port (for RS-232C connection)
Operating system	<ul style="list-style-type: none">• Windows XP (32-bit)• Windows Vista (32/64-bit)• Windows 7 (32/64-bit)• Windows 8• Windows 10

Initial Setup

The following operations must be performed before you can use the Multiple Display Administrator to manage your display(s).

Installing Multiple Display Administrator

Ensure that the computer meets the minimum system requirements set forth on [page 5](#).

1. Locate the **setup.exe** file and double-click it to begin installation.
2. Follow the on-screen instructions to complete the installation.

Connecting display(s) to the computer

The Multiple Display Administrator supports both Ethernet LAN and RS-232C daisy chain connections to your display(s). You can choose one that best suits your display deployment and network environment.



- For details on the location of ports and connectors, and instructions on the OSD settings, please refer to the documentations of the computer and display.
- Do not make LAN and RS-232C connections at the same time.

RJ-45 Ethernet connection

1. As illustrated in the figure below, connect the computer and displays to the Ethernet LAN or WAN network via a hub, switch or router using RJ-45 cables.

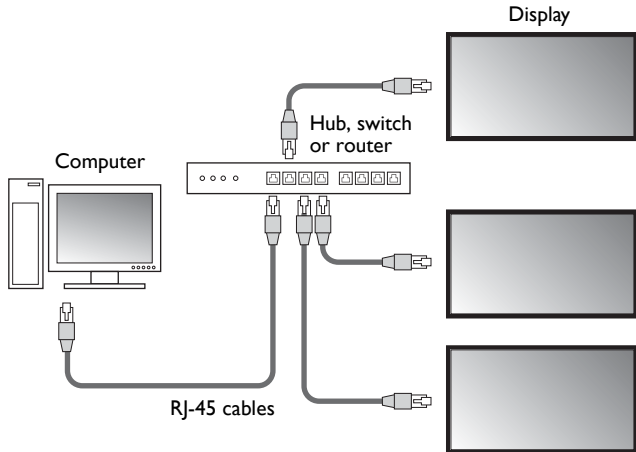

2. Open the displays' OSD menu and set the following settings:
 - Set the **Setting > Control Setting** option to **LAN**.
 - Set the **Setting > Network Setting** option to **DHCP** (if the IP address will be automatically assigned by a DHCP server) or **Manual** (if the IP address has to be assigned manually). You may need to contact your network administrator for assistance on these settings.



- If the **Network** setting is set to **Manual**, the computer and displays must have the same Subnet mask, Default gateway, Primary DNS and Secondary DNS settings.

RS-232C connection

1. Connect the RS-232C port on the computer to the RS-232C IN port on the first display using a RS-232C cable.
2. Connect the RS-232C OUT port on the first display to the RS-232C IN port of the second display using a RS-232 cable. Repeat this step to connect more displays. The diagram below shows the general connection scheme.

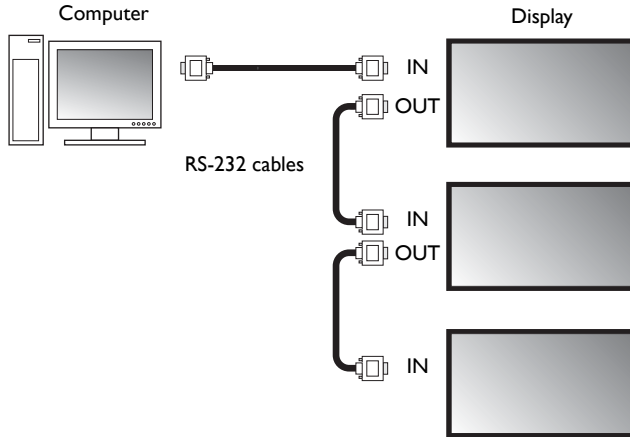

3. Open the displays' OSD menu and set the following settings:
 - Set the **Setting > Control Setting** option to **RS-232C**.
 - If you connect the computer to multiple displays, give each display a unique monitor ID using the **Setting > Set Monitor ID** option.



Be sure to assign a unique monitor ID for each display. The Multiple Display Administrator uses these IDs to identify and communicate with the displays.

Launching Multiple Display Administrator

To launch Multiple Display Administrator, click Windows **Start** button and select **Programs > MDA > MDA**. You can also double-click the **MDA** icon  on Windows Desktop to launch the program.

The default password is **0000**. If you change the default password, a dialog prompting you to enter ID and password will appear. Enter the new password and click **OK**. The dialog will not appear if the default password has not been changed. Multiple Display Administrator home screen will appear if you are successfully logged in.

The screenshot shows a 'LOGIN' dialog box with a close button (X) in the top right corner. It contains two input fields: 'ID:' with the text 'administrator' and 'Password:' which is currently empty. Below the fields are two buttons: 'OK' and 'Cancel'.



You can change the ID and password in the **Security** menu. Refer to [Changing login ID and password on page 28](#) for more information.

Overview of components and functions



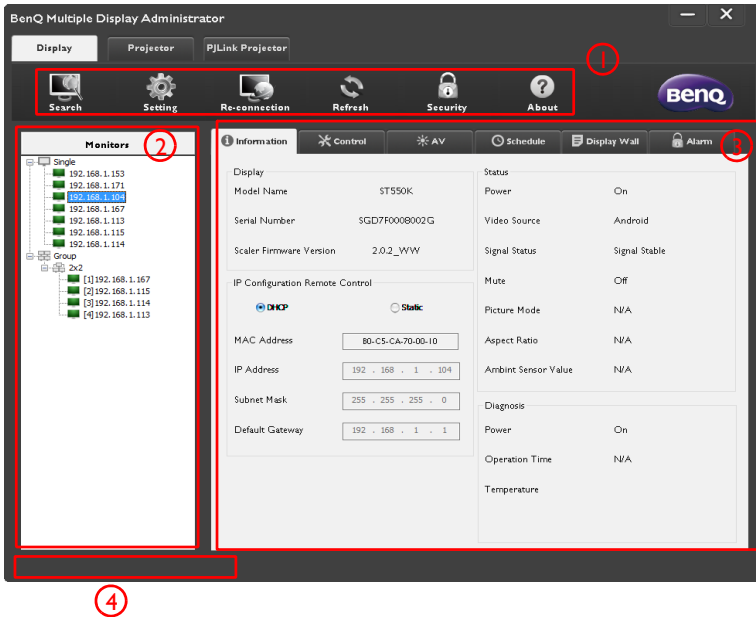

The Multiple Display Administrator home screen mainly consists of the following components:

1. **Toolbar:** provides functions for connection and security settings.
2. **Monitor list panel:** lists displays that are connected to the computer and found on the network.
3. **Control panel:** provides controls and settings for the display (and display groups) selected on the Monitor list panel.
4. **Notification area:** shows notifications and results of command execution.



Toolbar



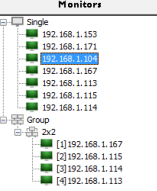
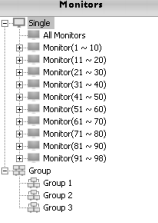

<p>Search</p>	<p>Searches displays that are connected to the network and adds them to the Monitor list panel.</p>
<p>Setting</p>	<p>Sets the connection mode between the computer and displays to Network or Serial (RS-232C).</p>
<p>Re-connection</p>	<p>Allows you to manually re-connect to the display or display group selected on the Monitor list panel.</p>

	<p>Refreshes the information and setting values on the Control panel (Information, Control, AV, Schedule, Display Wall and Alarm tabs).</p> <p> If the displays are connected via RS-232C connection, it may take some time to refresh information on the tabs due to the connection speed. Please wait until the information on the tabs is completely refreshed before performing any further operations.</p>
	<p>Allows you to change the user ID and password that are required for logging in to the Multiple Display Administrator.</p>
	<p>Changes the program's user interface language, shows software version and opens the online Help.</p>

Monitor list panel

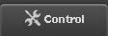
<p>Ethernet connection</p> 	<p>RS-232C connection</p> 	<p>The Monitor list panel lists displays that are currently connected to the computer and found on the network.</p> <ul style="list-style-type: none"> Displays found on the network will be listed under the Single node. Display groups will be listed under the Group node. You can create and edit display groups for management purposes. For example, if you select a display group and change settings on the Control panel, the command will be sent to all displays in the same display group.
--	---	---

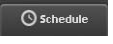
Control panel

	<p>Shows information, current status and settings of the display or display group selected on the Monitor list panel. See Information tab on page 15 for details.</p>
	<p>Provides controls for display's power, volume, and other settings. See on page 17 for details.</p>
	<p>Provides controls for display's audio and video settings. See AV tab on page 19 for details.</p>
	<p>Allows you to set different scheduled time intervals to automatically turn on/off the display. See Schedule tab on page 20 for details.</p>
	<p>Creates and adjusts a large screen matrix (display wall) for multiple displays. See Additional operations on page 28 for details.</p>
	<p>Configures email settings so that the Multiple Display Administrator can send temperature warning and status report messages via email. See Alarm tab on page 27 for details.</p>

Managing displays

Searching for displays

After you finish connecting display(s) to the computer, what you need to do next is to let the Multiple Display Administrator search for the displays and add them to the Monitor list panel.

Serial (RS-232C) connection

1. Click **Search** on the Toolbar. A dialog will appear asking you to specify the Communication Protocol.

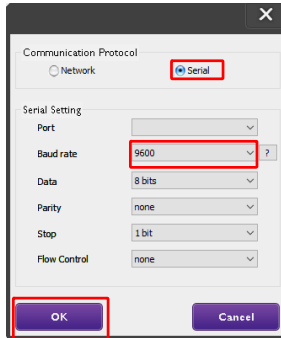

2. Select **Serial**, and continue to select the Baud rate, Data, Parity, Stop, and Flow Control.
3. Click **OK**. The Multiple Display Administrator will start searching for displays on the RS-232C network, and will list the displays found on the Monitor list panel when finished.

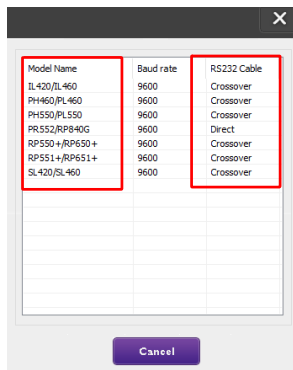

Ethernet (LAN) connection

1. Click **Setting** on the Toolbar. A dialog will appear asking you to specify the Communication Protocol.
2. Select **Network**, and click **OK**. The dialog below will follow.

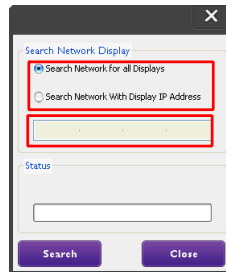
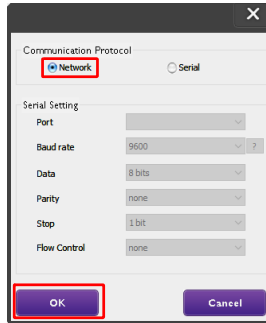



3. Click to select a suitable option:
 - If you want the Multiple Display Administrator to search for all displays on the same network, select **Search Network for all Displays**.
 - If you only want to search for a display with a specific IP address, click **Search Network With Display IP Address**, and then enter the IP address of the display.
4. Click **Search**. The Multiple Display Administrator will start searching for displays on the network, and the progress will be indicated in the **Status** area.
5. Click **Close** when the search is complete. The display(s) found will be listed on the Monitor list panel.

Managing displays on the Monitor list panel

After displays are searched and added to the Monitor list panel, you can perform various operations to manage the displays.

The connection status of displays on the Monitor list panel is indicated by the icons below:



- : the display is connected (online).
- : the display is not connected (offline). You can click **Re-connection** on the Toolbar to re-connect to the display.

Tagging a display

If displays are connected to the computer via Ethernet connection, they are named after their IP addresses on the Monitor list panel by default. You can give these displays different names (tags) for easier identification.

1. On the Monitor list panel, right-click on the display you want to add a tag, and select **Add Tag**.

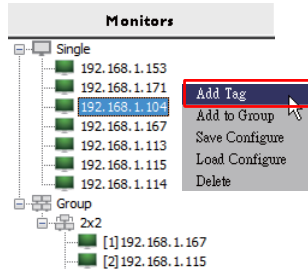

2. Enter the tag name in the dialog that follows, and click **Set**.

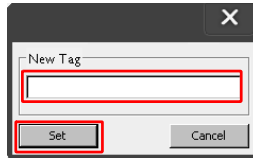

3. The tag you just added will appear in parentheses in front of the display's IP address.

Creating a group

You can create display groups for management purposes. For example, if you select a group and change settings on the Control panel, the command will be sent to all displays in the same group.

1. On the Monitor list panel, right-click on the **Group** node, and select **Make Group**.



2. Enter the group name in the dialog that follows, and click **OK**.

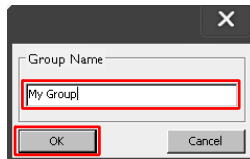

3. A new group will be created under the **Group** node.



Deleting a group

1. On the Monitor list panel, right-click on the display group you want to delete, and select **Delete**.



2. The selected group will be deleted.

Adding displays to an existing group

1. On the Monitor list panel, right-click on a display you want to add to a display group and select **Add to Group**.

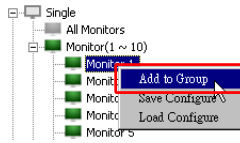

2. In the dialog that appears, select the group to which the display will be added, and then click **Select**.

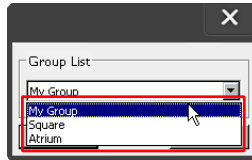

3. The display will be added to the group you selected.

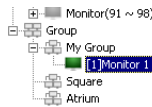

You can also drag a display and drop it to a group.

Deleting a display from a group

1. On the Monitor list panel, right-click on a display you want to delete from a display group and select **Delete**.

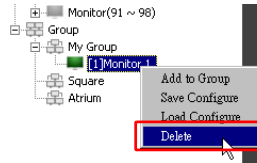

2. The selected display will be deleted from the group.

Deleting a display from the Monitor list panel

1. On the Monitor list panel, right-click on the display you want to delete under the **Single** node and select **Delete**.

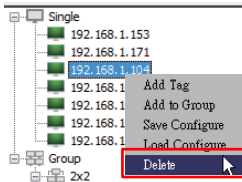

2. The selected display will be deleted.



If a display is deleted under the **Single** node, it will also be deleted from the group to which it belongs.

Setting display ID automatically

If displays are connected to the computer via Ethernet connection, you can use this function to set IDs for the displays automatically.

1. On the Monitor list panel, right-click on the **Single** node and select **Auto Set ID**.



2. The IDs of the displays will be assigned automatically.

Saving and loading display configuration files

With this function, you can save display settings on the Control panel as a configuration file (*.ini file) for backup purpose, and load the file when you want to restore these settings.

1. On the Monitor list panel, right-click on a display and select **Save Configure**.

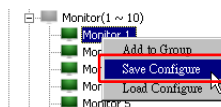

2. Specify the location where the file will be saved, and then click **Save**.

To load a configuration file, right-click on a display on the Monitor list panel and select **Load Configure**.

Setting up display configurations

You can use the settings and options on the Control panel to remotely set up various settings for a selected display or display group on the Monitor list panel.



Some controls and settings on the Control panel may not be available depending on your display model. A warning message will appear in the Notification area on the lower left corner of the program window if an unsupported control or setting is selected.

Information tab

The following information will be provided on the Information tab when a display is selected on the Monitor list panel.

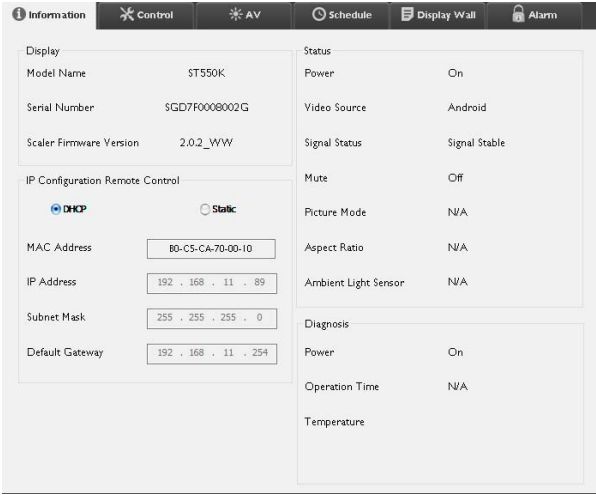

Item	Description	
Display	Model name	Model name of the display.
	Serial number	Serial number of the display.
	Scaler Firmware Version	Software (firmware) version of the display.
IP Configuration Remote Control	DHCP/Static	IP assignment method of current Ethernet connection.
	MAC Address	Network properties of current Ethernet connection.
	IP Address	
	Subnet Mask	
Default Gateway		

Control tab

The Control tab consists of controls for basic display operations.

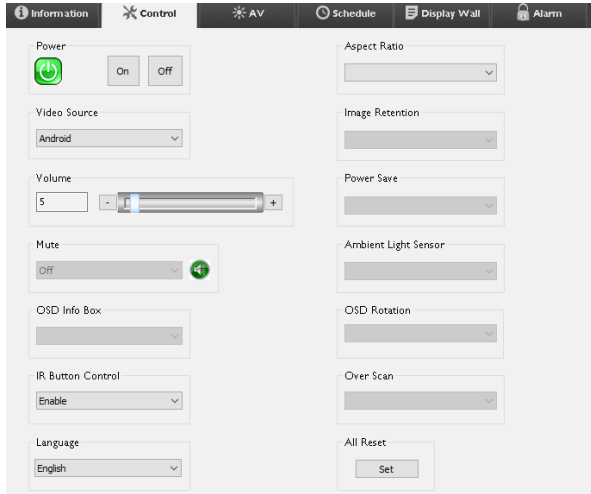

Item	Description
Power	Tab on or off to turn on/off the power of the display or puts the display to standby mode.
Video Source	Selects a video input source.
Volume	Adjusts audio volume.
Mute	Mutes or unmutes audio output.
OSD Info Box	Enables (shows) or disables (hides) the on-screen information box.
IR Button Control	Turns on or off the remote control lock and key lock functions.
Language	Changes the language of the OSD menu.
Aspect Ratio	Selects an image aspect ratio for the display.
Image Retention	Turns on or off the image retention prevention function.
Power Save	Changes the setting of the power save function.
Ambient Light Sensor	Turns on or off the ambient light sensor of the display.
OSD Rotation	Changes the orientation of the OSD menu.
Over Scan	Changes the setting of the overscan function.
All Reset	Resets all settings on the Control tab.

AV tab

The AV tab contains controls for picture quality and sound settings.

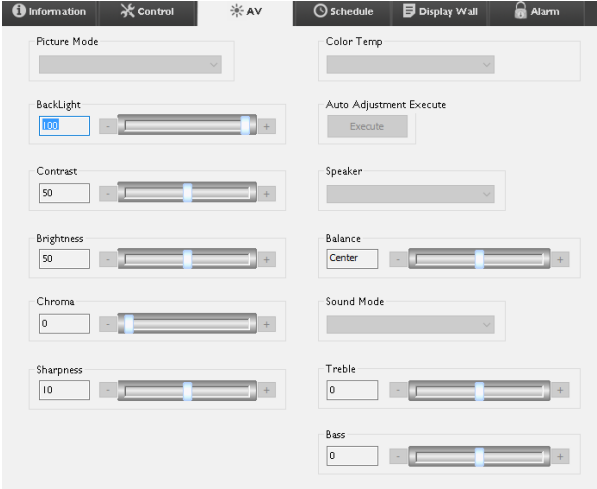

Item	Description
Picture Mode	Selects a preset picture mode.
Backlight	Adjusts the backlight intensity of the screen.
Contrast	Adjusts the image contrast.
Brightness	Adjusts the image brightness.
Chroma	Adjusts the color intensity of the image.
Sharpness	Adjusts the image sharpness.
Color Temp	Adjusts the color temperature.
Auto Adjustment Execute	Click the Execute button to trigger the auto adjustment function for VGA signal.
Speaker	Selects the destination or device for audio output.
Balance	Adjusts the balance of volume between the left and right speakers.
Sound Mode	Selects a preset sound mode for audio output.
Treble	Adjusts the audio treble.
Bass	Adjusts the audio bass.

Schedule tab

The Schedule tab provides controls by which you can set the display(s) to turn on or off (enter standby mode) automatically.

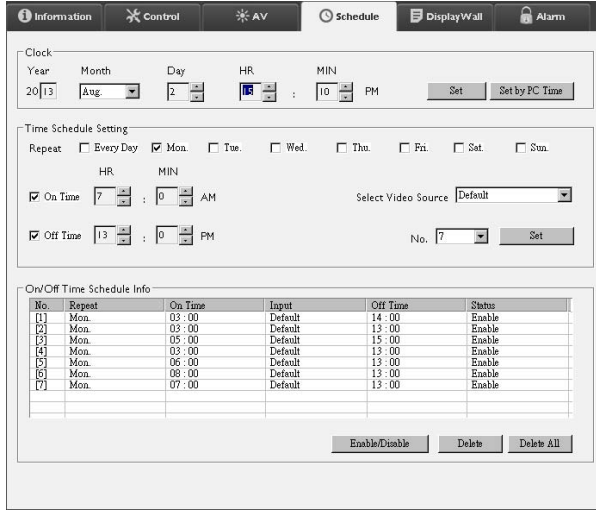

Item	Description
Clock	Allows you to set up current time manually. You can also click Set by PC Time to set the display to use the current time on the computer.
Time Schedule Setting	<p>Allows you to specify on and off time schedules.</p> <ol style="list-style-type: none"> 1. Set a repeat mode by checking a Repeat checkbox. (Every Day, Mon., Tue., etc.) 2. Set On Time (the time when the display will be turned on) and Off Time (the time when the display will be turned off). 3. Select an input source that will be used when the display is turned on from the Select Video Source drop-down list. 4. Specify the number of the schedule in the No. drop-down list. 5. Click the Set button to complete schedule settings. The on/off time schedule will appear in the On/Off Time Schedule Info area below.
On/Off Time Schedule Info	<p>Allows you to check and delete on/off time schedules.</p> <ul style="list-style-type: none"> • To enable or disable a time schedule, select a schedule and then click Enable/Disable. • To delete a time schedule, select a schedule you want to delete, and then click Delete. • To delete all time schedules, click Delete All.

Display Wall tab

Creating a display wall

You can follow the step-by-step instructions on the Display Wall tab to create a display wall that consists of multiple displays.

1. Create a display group, and add displays that will be used to create the video wall to the group. Refer to [Managing displays on the Monitor list panel on page 11](#) for how to create a display group and add displays to a group.
2. Click to select the display group you created in step 1, and then click **Create Tile Mode** on the Display Wall tab.



3. Specify the number of displays on the horizontal side (**H. Monitors**) and vertical side (**V. Monitors**) and then click **Next**.

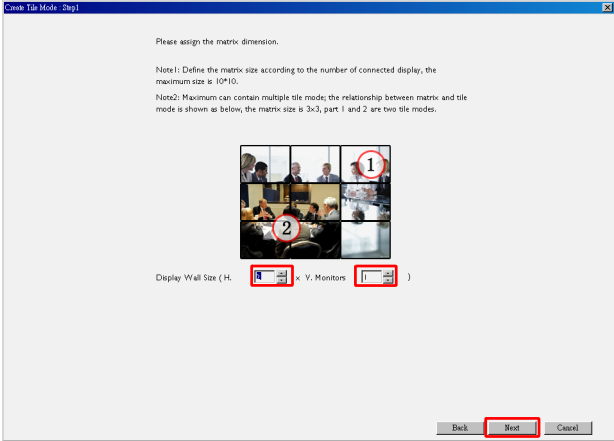



- You can create a display wall that consists of up to 10 x 10 displays.
- The number of displays in a display wall matrix should not exceed that in the display group with which you use to create a display wall. Otherwise the **Next** button will be grayed out.

4. Select the position of each display in the display wall by selecting the monitor ID (as shown in the Monitor list panel) of the display in each screen grid. Each screen grid must have a unique monitor ID. Click **Next** to continue.



5. Select a video input source for the display.

Scenario I: when a single input source is used for all displays

Select a video input source from the **Video Source** drop-down list, then click to select all screen grids below. Click **Next** to continue.

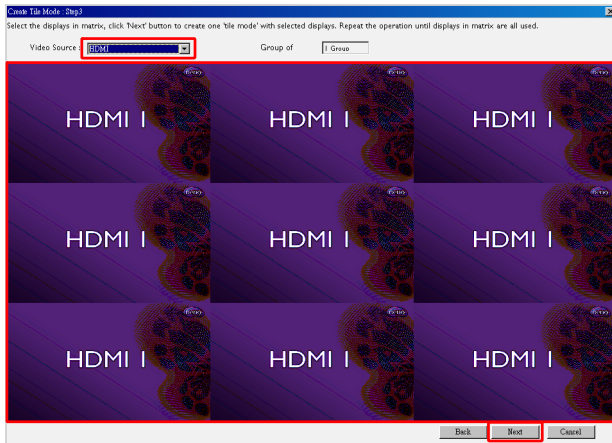

Scenario 2: when multiple input sources are used for different groups of displays

The example below shows how to set up 3 different groups of displays that use 3 different input sources (VGA, AV and HDMI) in the same display wall.

- a. Select **VGA** from the **Video Source** drop-down list, then click to select the screen grids (displays) that will use the VGA input. This is display group 1 that uses the VGA input. Click **Next** to continue.

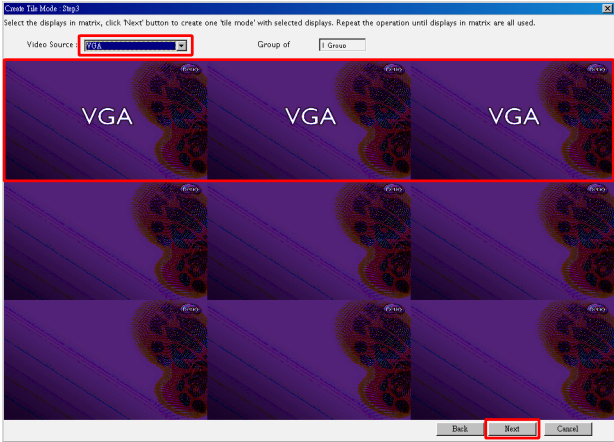

- b. Select **AV** from the **Video Source** drop-down list, then click to select the screen grids (displays) that will use the AV input. This is display group 2 that uses the AV input. Click **Next** to continue.

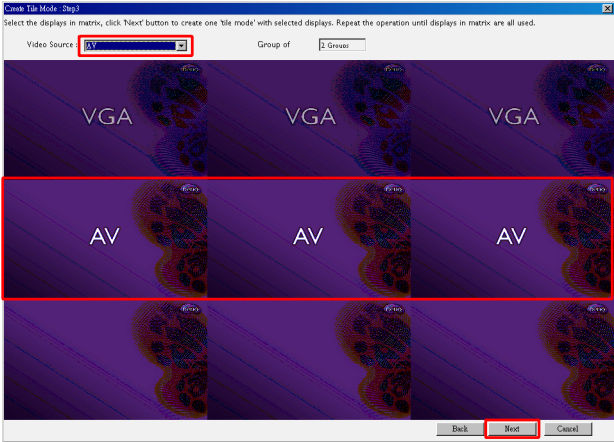

- c. Select **HDMI** from the **Video Source** drop-down list, then click to select the screen grids (displays) that will use the HDMI input. This is display group 3 that uses the HDMI input. Click **Next** to continue.

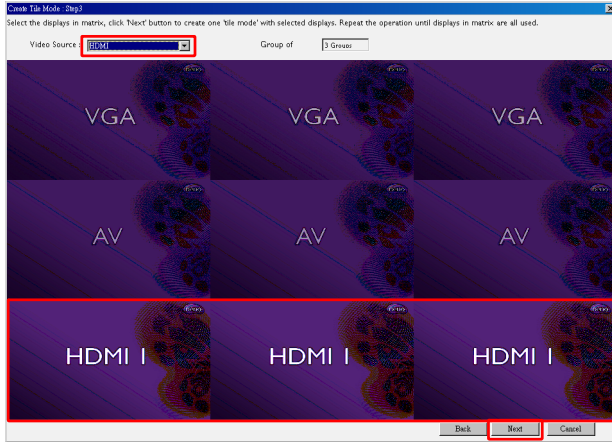

You can follow similar steps to specify different combinations of input sources and displays.

6. You have the option to switch the position of each display in the display wall by selecting a different horizontal or vertical position. Select a new position for the display(s) using the horizontal position and vertical position boxes if necessary. Click **Next** to continue.

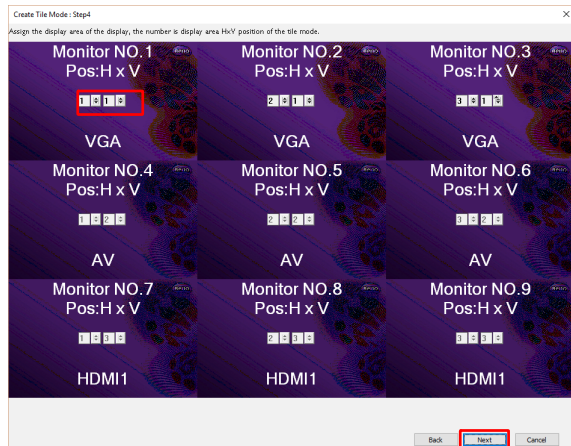
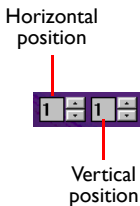

If the display wall contains multiple display groups that use different input sources, you can only change either the horizontal position or vertical position (the horizontal position or vertical position box will be grayed out), depending on the arrangement of displays.

- 7. An overview of the display wall setup will follow. Check the setup and if it is OK, click **Finish** to complete display wall settings.

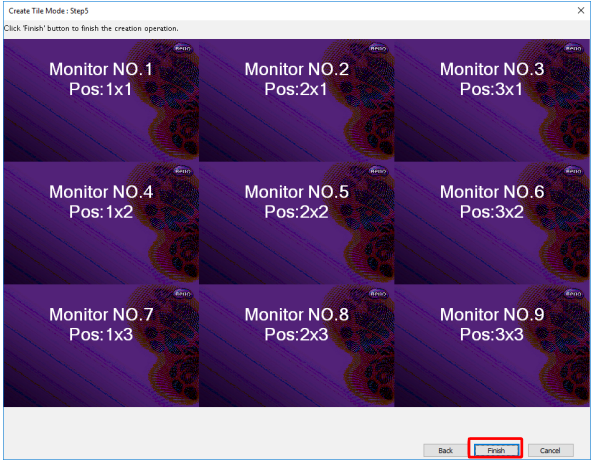

Modifying display wall settings

You can modify display wall settings of each display separately.

- 1. Click to select a display of a display wall group on the Monitor list panel.
- 2. Click **Adjust Tile Mode** on the Display Wall tab.



3. Modify the settings as necessary.

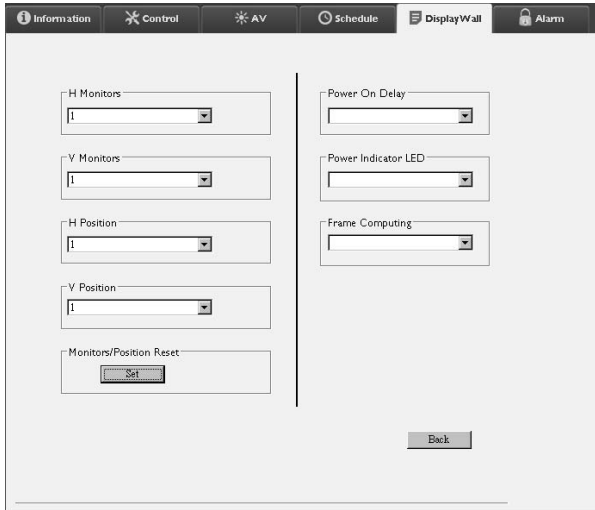

Item	Description
H. Monitors	Specifies the number of displays on the horizontal side.
V. Monitors	Specifies the number of displays on the vertical side.
H. Position	Specifies the position of the display on the horizontal side.
V. Position	Specifies the position of the display on the vertical side.
Monitors/Position Reset	Clicks the Set button to reset the display's display wall settings, including H. Monitors, V. Monitors, H. Position and V. Position settings.
Power On Delay	Enables (On) or disables (Off) the power on delay function. Once enabled, when all displays in a display group are turned on at the same time using the Power function on the Control tab, this feature automatically sets each display to power on at a slight time difference to avoid sudden rise of power consumption.
Power Indicator LED	Turns on or off the power indicator LED on the display.
Frame Computing	Turns on or off the frame computing function of the display that automatically adjust the image to compensate for the width of the monitor bezels in order to accurately display the image.

4. Click **Back** to save settings and return to the Display Wall tab.

Alarm tab

The Alarm tab contains email settings that allow the Multiple Display Administrator to send email messages to specified recipients when the internal temperature of the display is too high, or when you have activated the status report function.

The screenshot shows the 'Alarm' tab configuration window. At the top, there are navigation tabs: Information, Control, AV, Schedule, Display Wall, and Alarm. The main content area is divided into three sections:

- Email Setting:** Contains three text input fields labeled 'To:', 'Cc:', and 'From:'.
- SMTP Setting:** Contains three text input fields labeled 'SMTP Server:', 'User Name:', and 'Password:'. Below these is a checked checkbox for 'Status Report', a 'Day of Week:' dropdown menu, and a 'Time:' field with two input boxes (0 and 0) and a 'Set' button.
- Advance:** Contains a note: 'Note: After set email and SMTP, these functions can operate.' Below the note is a 'Test Email' button and an 'Alarm Temperature' dropdown menu (set to 0) with a 'Set' button.

Item		Description
Email Setting	To:	Specifies the recipients and sender of the email.
	CC:	
	From:	
SMTP Setting	SMTP Server	Specifies the SMTP settings.
	User Name	
	Password	
	Status Report	Checks this checkbox to let the Multiple Display Administrator send a status report of the display(s) via email at a specific time.
	Day of Week	Specifies the time at which the status report will be sent.
	Time	
	Set button	Clicks this button to save settings.
Advance	Test Email button	Clicks this button to send a test email when the setting is completed.
	Alarm temperature	Specifies the temperature limit. If the display's internal temperature exceeds this limit, a warning email message will be sent.
	Set button	Clicks this button to save settings.

Additional operations

Changing login ID and password

You can change the ID and password that are used to log in to the Multiple Display Administrator.



The ID and password can be changed, however, you cannot create multiple ID and password combinations.

1. Click **Security** on the Toolbar. The following dialog will appear.

2. Enter current ID and password in the **ID** and **Password** fields, and then click **Confirm**. If the ID and password are verified successfully, you can continue to the next step.
3. Enter the new ID and password in the **ID**, **Password** and **Verify** fields below, and then click **Change**.
4. If you change the default password **0000**, a reminder dialog will appear whenever you log in. The dialog will not appear if the default password has not been changed.



The ID and password are case-sensitive. You can use alphanumeric and special characters such as !,@,#,\$,%,&,*,-,_,=,+,.? for the ID and password.

Changing language

You can change the user interface language of the Multiple Display Administrator whenever necessary.

To change language, click **About** on the Toolbar and select a preferred language.



Troubleshooting

If you encounter problems while using the Multiple Display Administrator, please refer to the following troubleshooting tips to try to solve the problems by yourself. If the problem persists, please contact BenQ Customer Support for help.

Problem	Solution
<p>Cannot connect to the display(s)</p>	<p>Check the following:</p> <ul style="list-style-type: none"> • Check the cable connection. Is the display correctly connected to the computer? • Is the display turned on? • Is the COM port setting correct? • Is the display's network setting correct?